

# **ANILAM**

Conversational  
Programming  
for  
6000M, 5000M CNC

### **Warranty**

ANILAM warrants its products to be free from defects in material and workmanship for one (1) year from date of installation. At our option, we will repair or replace any defective product upon prepaid return to our factory.

This warranty applies to all products when used in a normal industrial environment. Any unauthorized tampering, misuse or neglect will make this warranty null and void.

Under no circumstances will ANILAM, any affiliate, or related company assume any liability for loss of use or for any direct or consequential damages.

The foregoing warranties are in lieu of all other warranties expressed or implied, including, but not limited to, the implied warranties of merchantability and fitness for a particular purpose.

The information in this manual has been thoroughly reviewed and is believed to be accurate. ANILAM reserves the right to make changes to improve reliability, function, or design without notice. ANILAM assumes no liability arising out of the application or use of the product described herein.

Copyright 2005 ACU-RITE Companies, Inc.

**Section 1 - Introduction**

**Section 2 - Conversational Mode Programming Hot Keys**

Programming Hot Keys.....2-1  
 Editing Keys.....2-2

**Section 3 - Writing Conversational Programs**

Program Basics .....3-1  
 Developing Part Programs.....3-1  
 Writing Program Blocks .....3-3  
     Using Graphic Menus.....3-3  
 No Move Blocks.....3-4  
     Programming an Absolute/Incremental Mode Change.....3-4  
     Programming an Inch/MM Mode Change.....3-4  
     Programming a Tool Change .....3-5  
     Activating a Tool.....3-5  
     Activating Tool-Diameter Compensation .....3-6  
     Programming a Dwell .....3-8  
     Programming a Return to Machine Zero .....3-9  
     Programming Fixture Offsets.....3-10  
     Resetting Absolute Zero (Part Zero) .....3-12  
     Programming a Plane Change .....3-14  
     Programming a Feedrate Change .....3-15  
     Programming a Spindle RPM.....3-15  
 Straight Moves.....3-16  
     Programming a Rapid Move.....3-16  
     Programming a Line Move .....3-17  
     Programming a Modal Move .....3-17  
 Line or Rapid Moves.....3-18  
     Programming a Move Using XY Location, Radii, or Angles .....3-19  
 Arcs .....3-20  
     Selecting the Plane for an Arc.....3-20  
     Programming an Arc Using an Endpoint and Radius.....3-20  
     Programming an Arc Using the Center and Endpoint .....3-22  
     Programming an Arc Using the Center and the Included Angle.....3-24  
 Programming M-Code Blocks.....3-26  
     Dry Run M-Codes.....3-27

**Section 4 - Programming Canned Cycles, Ellipses, and Spirals**

Drilling Cycles .....4-1  
     Basic Drill Cycle .....4-1  
     Peck Drilling Cycle .....4-2  
     Boring Cycle .....4-4  
     Chip Break Cycle.....4-5  
     Tapping Cycle .....4-6  
     Drill Pattern.....4-8

Bolt Hole Pattern .....	4-9
Thread Milling Cycle .....	4-10
Pocket Cycles .....	4-12
Facing Cycle .....	4-13
Rectangular Profile Cycle .....	4-15
Circular Profile Cycle .....	4-17
Rectangular Pocket Cycle .....	4-19
Circular Pocket Cycle .....	4-21
Frame Pocket Cycle .....	4-23
Hole - Mill Cycle .....	4-25
Irregular Pocket Cycle .....	4-27
Pockets with Islands .....	4-32
Subprograms .....	4-37
Situation: 1 (Repetitive Drilling Cycle) .....	4-37
Situation: 2 (Rough and Finish Cycles) .....	4-37
Subprogram Structure .....	4-37
Subprogram Example .....	4-37
Organizing Programs Containing Subprograms .....	4-38
Calling Subprograms from the Main Program .....	4-39
Ending Main Programs .....	4-39
Starting Subprograms .....	4-39
Ending Subprograms .....	4-39
Looping Subprograms .....	4-40
Rotating, Mirroring, and Scaling Subprograms (RMS) .....	4-40
Ellipses and Spirals .....	4-41
Plane Selection .....	4-41
Programming an Ellipse .....	4-42
Programming a Spiral .....	4-44
Mold Cycles .....	4-45
Programming a Mold Rotation .....	4-45
Rotations Around X and Y Axes (Small Radius) .....	4-46
Rotations Around X and Y Axes (Large Radius) .....	4-50
Rotation Around the Z-Axis .....	4-51
Programming an Elbow Milling Cycle .....	4-53
Engraving, Repeat, and Mill Cycles .....	4-58
Engraving Cycle .....	4-58
Repeat Cycle .....	4-60
Mill Cycle .....	4-62
Probing Cycles .....	4-64
Tool Probe Cycles .....	4-64
Spindle Probe Cycles .....	4-81
 <b>Section 5 - Editing Programs</b>	
Activating the Conversational Program Editor .....	5-1
The Program Editor Screen .....	5-2
Saving Edits .....	5-3
Canceling Unsaved Edits .....	5-3
Deleting a Block .....	5-3

Inserting a Block .....	5-4
Editing Blocks .....	5-4
Searching Blocks for Words or Numbers .....	5-4
Scrolling the Program Listing .....	5-4
Paging through the Program Listing .....	5-5
Jumping to First or Last Block in the Program .....	5-5
Using Comments .....	5-5
Writing a Comment Block .....	5-5
Commenting Out Existing Blocks .....	5-5
Canceling a Comment .....	5-6
Using Block Operations to Edit a Program .....	5-6
<b>Section 6 - Calculators</b>	
CNC Calculator Package .....	6-1
Math Calculator .....	6-1
Math Calculator Basics .....	6-2
Operations Involving Two Numbers .....	6-3
Math with a Column of Numbers .....	6-3
Using Parentheses .....	6-3
Using Additional Functions .....	6-4
Storing Numbers from the Math Calculator .....	6-5
Right Triangle Calculator .....	6-5
Using the Triangle Calculator .....	6-6
Storing Right Triangle Calculator Results .....	6-6
Hiding the Right Triangle Calculator Screen .....	6-7
Geometry Calculator .....	6-7
Activating the Geometry Calculator .....	6-7
Geometry Calculator Screen .....	6-8
Using the Geometry Calculator .....	6-8
Point Templates .....	6-10
Line Templates .....	6-11
Circle Templates .....	6-12
Deleting Selected Elements .....	6-13
Deleting All Elements .....	6-13
Listing All Geometry Elements .....	6-13
Calculating the Distance between Two Elements .....	6-14
Last Position Recall .....	6-14
Recalling Values into a Program .....	6-15
Recalling Values from the Math Calculator .....	6-15
Recalling Values from the Right Triangle Calculator .....	6-16
Recalling Values from the Geometry Calculator .....	6-17
Recalling Values from One Calculator into Another .....	6-17
<b>Index</b> .....	Index-1

## Section 1 - Introduction

The 6000M and 5000M CNCs support a conversational programming feature. This feature is standard on 6000M, and an option on 5000M. The feature allows these CNCs to be programmed in conversational or G-code. The conversational programming language in these CNCs is compatible with the conversational programming in the 3000M 3-Axis Kit CNC. The program type (conversational or G-code) is determined when you create the program. Creating a program with extension of .M makes it a conversational program. Creating a program with extension of .G (or no extension) makes it a G-code program. If no extension is assigned, the default extension .G is assigned.

The Program Management screen normally displays programs with .G extension. To use conversational programs, the Program Management screen must display the .M programs also. To always display conversational programs, set the "Program directory pattern" parameter under Control Software in the Setup Utility to \*.G+\*.M. For more information on this, refer to [5000M CNC Setup Utility Manual, P/N 70000509](#), or [6000M CNC Setup Utility Manual, P/N 70000490](#). Alternatively, in the Program Management screen you can press **Shift + F9** until the conversational programs are visible.

Conversational programs are used the same way as G-code programs. They can be edited, drawn, and executed in Auto or Single Step. The only feature that will operate differently is the editor. Conversational programs are edited with the conversational editor (similar to the editor in the 3000M 3-Axis Kit) while G-code programs are edited with the standard G-code editor. The program extension determines the editor that is used.

















For more information on the Program Management, Draw, Auto/S.Step, etc. refer to [5000M CNC Programming and Operations Manual, P/N 70000508](#), or [6000M CNC Programming and Operations Manual, P/N 70000487](#).

## Section 2 - Conversational Mode Programming Hot Keys

### Programming Hot Keys

Programming hot keys allow you to enter position coordinates and provide quick access to functions that speed up programming. They are active in the Edit Mode. Refer to **Table 2-1**.



**Table 2-1, Programming - Hot Keys**

Label or Name	Key Face	Purpose
Letter X		Selects X-axis for position inputs.
Letter Y		Selects Y-axis for position inputs.
Letter Z		Selects Z-axis for position inputs.
Letter E		Switches CNC between Absolute and Incremental Modes.
Number 0 (Comment)		Zero / Switches comment asterisk in edit mode.
1/RAPID		One / Hot key for programming a Rapid move.
2/LINE		Two / Hot key for programming a Line move.
3/ARC		Three / Hot key for programming an Arc.
4/FEED		Four / Hot key for changing feedrate.
5/TOOL		Five / Hot key for programming a tool.
6/MCODE		Six / Hot key for programming an M-code.
7/UNIT		Seven / Hot key for switching between inches (Inch) and millimeters (mm).
8/DWELL		Eight / Hot key for programming a Dwell.
9/PLANE		Nine / Hot key for selecting a plane.
+/-		Sign change / Toggle hot key.
Period/Decima I Point (Spindle RPM)		Decimal point / Hot key for programming the spindle RPM.

## Editing Keys

Editing keys allow you to edit program blocks. These keys are located below the Programming Hot Keys. Refer to **Table 2-2**.

**Table 2-2, Editing Keys**

<b>Label or Name</b>	<b>Key Face</b>	<b>Purpose</b>
<b>CLEAR</b>		Clears the selected messages values, commands, and program blocks.
<b>ARROW</b>		Allows you to move highlight bars and cursor around the screen.
<b>ENTER</b>		Selects blocks for editing, activates menu selections, activates number entry.



## Section 3 - Writing Conversational Programs

### Program Basics

Each program consists of blocks of instructions that direct machine movements. Give each program a unique name.

Many settings remain active until changed or turned off. These are modal settings. For example, move type (Rapid/Feed), feedrate (IPM), units (Inch/MM), or ABS/INCR.

Write programs with combinations of moves, mode changes, and canned cycles. The CNC has a built-in library of canned cycles stored in its permanent memory.

### Developing Part Programs

First, decide how to clamp the part and where to set Part Zero (Absolute Zero). Locate Part Zero at a point on the work positively positioned by the clamping fixture. This allows consistent machining of subsequent parts. Since Absolute positions are measured from Part Zero, locate Part Zero at a convenient location.

Determine the required tools and set the length offset for each tool.

Refer to the blueprint to select a Part Zero. Note the moves, positions, and tools needed to cut the part. The CNC has a calculator that finds coordinates for complex geometric shapes (refer to "[Section 6 - Calculators](#)").

To develop a part program:

1. Enter the Program Directory (the **PROGRAM** screen) and create the program for the part. Use the extension **.M**.
2. Enter the Program Editor (the **Edit** screen) to open the new program and begin to write blocks (refer to "[Section 5 - Editing Programs](#)").
3. The first block in a program is usually an Absolute Mode block. Put the CNC in the Absolute Mode at the start of a program to enable absolute positioning. (Use Incremental Mode only when specifically needed.)
4. Put the CNC in the appropriate Inch/MM Mode in the second block.
5. In the first move of the program, rapid to Tool #0, Z0 to retract the quill fully for the next move.
6. In the second move, rapid to a convenient part-change position.
7. Execute moves toward a part in two steps: A Rapid X, Y move at a clear height, followed by a Z move to 0.1 inch (2mm) above the surface of the cut (standard starting height). If necessary, activate the first tool mount at this time.

8. Subsequent blocks in the program are the moves, cycles, and tool changes required to machine the part.
9. Make the last three blocks of the program as follows:
  - a) a Rapid move to Tool #0, Z0,
  - b) a Rapid XY move to the same part change position used at the start of the program, and
  - c) an **EndMain** block.
10. To verify and troubleshoot finished programs, run them in Draw Graphics Mode.
11. Secure the work on the table with the appropriate work-holding device.
12. Go to the Manual screen and set Part Zero at a convenient point on the part.
13. Go to the Tool Page and organize the tooling. Assign each tool a number (in the order of use). Assign length offset and tool diameter as appropriate.
14. If Fixture Offsets are used, define them in the Fixture Offsets Table. Refer to "[Programming Fixture Offsets](#)" in this section.
15. Before you cut a part, perform a dry run. There are several ways to get a close look at the programmed moves. Run the program in Motion Mode to hold between each move or in Single-Step Mode to hold between each block. Run the program with no tool installed.
16. After a successful dry run, the program is ready for production. Back up the program for safekeeping.

## Writing Program Blocks

You can program a block for a move type, mode, or cycle using one of the following: hot keys, soft keys, or pop-up menus.

To program a block, activate its graphic menu and fill in the appropriate values. To save a program block, press **Save (F10)** or press **ENTER** on the last entry field in the graphic menu. The CNC adds the new block to the Program Listing.

The last block of the Main Program must be **EndMain**. If this block is omitted, a warning displays stating “Missing M2 or M30!”

The **<End Of Program>** block is the last line of a program. The CNC automatically numbers new blocks and inserts them in front of the **<End Of Program>** block.

## Using Graphic Menus

The Program Editor displays full screen graphic menus to write and edit program blocks. Refer to **Figure 3-1**.

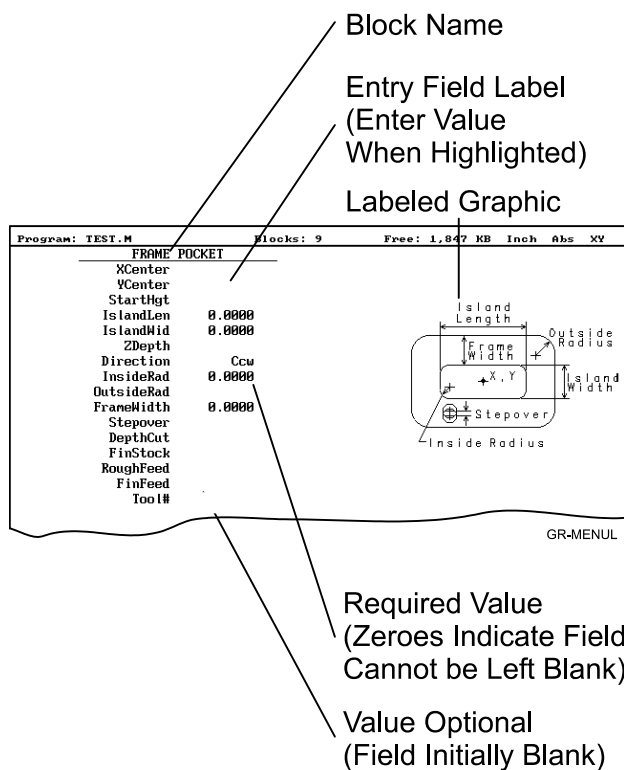

**Figure 3-1, Sample Graphic Menu**

Graphic menus activate with the first entry field highlighted. To type values, highlight the appropriate entry field. Press **ENTER** to advance the highlight to the next entry field. With the last entry field highlighted, press **ENTER** to close the menu and add the block to the program.

Press **Save (F10)** from any entry field to close the graphic menu and add the block to the program. Move the highlight from field to field using the **ARROW** keys. Fill out entry fields in any order.

Press **CLEAR** to remove values in the highlighted field.

There are two types of entry fields in a graphic menu:

**Optional entry fields** are blank when the graphic menu activates.

**Required entry fields** contain **0.000** when the graphic menu activates.

Required entry fields contain a 0.0000 default value. Change the value as required. Optional entry fields do not require a value. When left blank, the CNC usually assumes a default value or position. If the optional field is a position, the value defaults to the current position. If the optional field is a mode or tool change, the current mode and tool remain active. If the optional field is an angle, the value defaults to 0.0 degrees.

Type decimal points and negative signs where needed. Otherwise, the CNC assumes a positive whole number.

Press **+/-** to insert a negative sign or toggle selections in some entry fields (for example, **Cw/Ccw** fields).

### No Move Blocks

No Move Blocks does not initiate machine moves. Use No Move Blocks to set modes (Incremental/Absolute, etc.), activate tools (**Tool#**), and set feedrates (**Feed**).

#### Programming an Absolute/Incremental Mode Change

A **Dim** (dimension) block sets the Absolute (**Abs.**) or Incremental (**Incr.**) Mode.

To program a **Dim** block:

1. In Edit Mode, press the Letter E. The **SET ABS/INCR DIMENSION** graphic menu prompts you to select **Abs** or **Incr**.
2. Press **+/-** to toggle the mode.
3. Press **Save (F10)** or **ENTER** to add the block to the Program Listing.

#### Programming an Inch/MM Mode Change

A Unit block sets the Inch (**Inch**) or Millimeter (**MM**) Mode.

To program a Unit block:

1. In Edit Mode, press **7/UNIT**. The **SET INCH/MM UNIT** graphic menu prompts you to select **Inch/MM**.
2. Press **+/-** to toggle the selection.
3. Press **Save (F10)** or **ENTER** to add block to the Program Listing.

### Programming a Tool Change

Identify tools with tool numbers. When you activate a tool, its tool length and diameter offsets activate. List these values on the corresponding row of the Tool Page.

Tool-length offset remains in effect until a different tool activates. Always turn off tool-diameter compensation and ramp off before activating a new tool.

**NOTE:** Each time a tool activates, the CNC holds the program to permit installation of the new tool. Programming unnecessary tool changes slows down production.

Activate Tool #0 to set the tool-length offset and diameter to 0.0.

To change a tool:

**NOTE:** An absolute move to Tool #0, Z0 fully retracts the quill. An incremental command to Z0 maintains the current position.

1. In Absolute Mode, program a Tool #0, Rapid Z0 to cancel length offsets and retract the quill to a safe position.
2. Program a Rapid move to the tool change XY position (usually Machine Zero).
3. Program a block to activate the required tool (example: **Tool#1**). When the CNC encounters the **Tool#** command, it holds program execution. The operator can now change the tool.
4. Press **START** to resume operation. The CNC activates applicable tool compensation.

### Activating a Tool

To activate a tool:

1. In Edit Mode, press **5/TOOL**. The **TOOL MOUNT** graphic menu prompts for **Tool #**.
2. Type tool number and press **ENTER**.
3. The cursor advances to the M-Code field. If you have Automatic Tool Changer, type the appropriate activation M-Code. (For example, type **6**)
4. Press **ENTER** to add the **Tool#** block to the Program Listing.

### Activating Tool-Diameter Compensation

Turn compensation on or off in (Rapid or Line) ramp moves. Ramp moves offset the tool on the programmed path by half the tool diameter. Tool compensation affects all subsequent moves until canceled.

The **ToolComp** command, available in Line or Rapid graphic menus, sets the required tool compensation. Settings include:

- Left** (of the path)
- Right** (of the path)
- Off** (cancel compensation)

When the field is left blank, the current compensation, if any, remains in effect.

Many canned cycles include automatic tool compensation. Activate the correct tool diameter to ensure accuracy in these cycles. The required tool activates within the cycle.

Refer to **Table 3-1** for a list of move and cycle compensation requirements.

**Table 3-1, Move and Cycle Compensation Requirements**

Move or Cycle	Program a Rapid or Line move to activate tool comp before you program the move or cycle. Tool diameter must be active.	Activate/deactivate compensation automatically when you program the move or cycle. Tool diameter must be active.
<b>Rapid</b>	X	---
<b>Line</b>	X	---
<b>Modal</b>	X	---
<b>Arc</b>	X	---
<b>Ellipse</b> (Has special requirements. Refer to " <a href="#">Section 4 - Programming Canned Cycles, Ellipses, and Spirals</a> " for more information.)	X	---
<b>Spiral</b> (No compensation available.)	---	---

*(Continued...)*

**Table 3-1, Move and Cycle Compensation Requirements (Continued)**

<b>Move or Cycle</b>	<b>Program a Rapid or Line move to activate tool comp before you program the move or cycle. Tool diameter must be active.</b>	<b>Activate/deactivate compensation automatically when you program the move or cycle. Tool diameter must be active.</b>
<b>Face</b> (Affects only step-over.)	---	X
<b>Rectangular Profile Cycle</b>	---	X
<b>Circular Profile Cycle</b>	---	X
<b>Rectangular Pocket Cycle</b>	---	X
<b>Circular Pocket Cycle</b>	---	X
<b>Frame Pocket Cycle</b>	---	X
<b>Irregular Pocket Cycle</b>	---	X
<b>Mold Rotation Cycle</b> (Has special requirements. Refer to " <a href="#">Section 4 - Programming Canned Cycles, Ellipses, and Spirals</a> " for more information.)	---	X
<b>Elbow Mold Cycle</b> (No compensation available.)	---	---

## Programming a Dwell

**Dwell** pauses a running program for a specified length of time, in seconds. Dwell resolution is 0.1 sec. When the operator types 0.0 seconds (infinite dwell), the CNC will hold indefinitely. Press **START** to restart the CNC after an infinite dwell.

To program a Dwell using hot keys:

1. In Edit Mode, press **8/DWELL**. The **DWELL** graphic menu prompts for length of time in seconds.
2. Type the time and press **ENTER** to add Dwell block to the Program Listing.

To program a Dwell using soft keys:

1. In Edit Mode, press **Sub (F8)** to display the Secondary soft key functions.
2. Press **Dwell (F7)** to activate the **DWELL** graphic menu.
3. Type the time and press **ENTER** to add Dwell block to the Program Listing.



### Programming a Return to Machine Zero

**NOTE:** The CNC measures all entered coordinates in the Machine Home graphic menu from Machine Zero. The CNC homes axes one at a time, in the order indicated in the Setup Utility.

A **Home** block re-establishes a permanent reference position located on the machine. The position is called Machine Zero. Program a Home block using one of the two methods described in **Table 3-2**.

**Table 3-2, Homing Methods**

Homing Method	Required Action
<p><b>1. Indicate axes</b></p>	<p>Activate Machine Home graphic menu. Press required <b>X, Y, Z</b>-axis keys. On each axis selected, machine feeds from the current position to the limit switch, reverses direction and travels to the first detected zero crossing and sets Machine Zero at that point.</p>
<p><b>2. Enter coordinates</b></p>	<p>Activate Machine Home graphic menu. For each required axis, highlight the axis entry field and type a coordinate (example: X0, Y-1, Z-4). The machine rapids to the typed coordinate, then feeds to the limit switch, reverses direction and travels to the first detected zero crossing, and sets Machine Zero at that point.</p>

Use Homing Method 1 to execute a homing sequence in feed. Use Homing Method 2 to execute a homing sequence that rapids to the entered coordinate, then initiates the homing sequence.

To activate the Machine Home graphic menu:

1. In the Edit Mode, press **Mill (F5)** to display the Mill soft keys.
2. Press **More (F7)** to display the More pop-up menu.
3. Highlight **Home** and press **ENTER** to display the Machine Home graphic menu.

The method used to set Machine Zero depends on which options the builder installs. Check with the machine builder for detailed information.

## Programming Fixture Offsets

Refer to **Figure 3-2**.

**NOTE:** Presets and SetZero will work with Fixture Offsets.

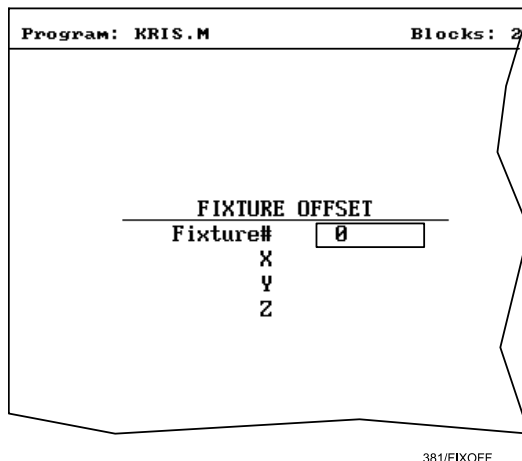

**Figure 3-2, Fixture Offset Graphic Menu**

To program:

1. In Edit Mode, press **Mill (F5)** to display the Mill soft keys.
2. Press **More (F7)** to display the More pop-up menu.
3. Select **Offsets** and press **ENTER** to display the Fixture Offset graphic menu.
4. Fill in the labeled entry fields, as follows:

- |                 |  |
|-----------------|--|
| <b>Fixture#</b> | The Fixture-Offset number. Indicates which set of values from the Fixture Offsets Table will be activated or changed. Type a number <b>1</b> through <b>99</b> , corresponding to the Fixture Offsets Table, to activate or change an offset. Type <b>0</b> to cancel fixture offsets.   |
| <b>X</b>        | X-offset coordinate. If you do not type a value, the CNC activates the offsets listed in the Fixture Offsets Table for the entered <b>Fixture#</b> . If you do type a value, the CNC applies the entered offset. When the program runs, the CNC updates the Fixture Offsets Table with the specified X offset and clears the previous value. Optional. |
| <b>Y</b>        | Y-offset coordinate. If you do not type a value, the CNC activates the offsets listed in the Fixture Offsets Table for the entered <b>Fixture#</b> . If you do type a value, the CNC applies the entered offset. When the program runs, the CNC updates the Fixture Offsets Table with the specified Y offset and clears the previous value. Optional. |

**Z** Z-Offset coordinate. If you do not type a value, the CNC activates the offsets listed in the Fixture Offsets Table for the entered **Fixture#**. If you do type a value, the CNC applies the entered offset. When the program runs, the CNC updates the Fixture Offsets Table with the specified Z offset and clears the previous value. Optional.

To cancel Fixture Offsets:

1. In Edit Mode, press **Mill (F5)** to display the Mill soft keys.
2. Press **More (F7)** to display the More pop-up menu.
3. Select **Offsets** and press **ENTER** to display the **Fixture Offset** graphic menu.
4. Select **Fixture#**. In the highlighted entry field, type **0** to cancel Fixture Offsets. (Do not fill in the other entry fields.)

**Fixture Offsets Table**

The Fixture Offsets Table, accessed using the Tool Page, contains the entered values for Fixture Offsets 1 through 99. Refer to **Figure 3-3**.

**NOTE:** Handwheel and Jog features are available while the Fixture Offsets Table is active.

Fixture #		G53 Offset		
	X	Y	Z	
1.▶	0.0000	1.0000	0.0000	
2.	0.0000	0.0000	0.0000	
3.	0.0000	0.0000	0.0000	
4.	0.0000	0.0000	0.0000	
5.	0.0000	0.0000	0.0000	
6.	0.0000	0.0000	0.0000	
7.	0.0000	0.0000	0.0000	
8.	0.0000	0.0000	0.0000	
9.	0.0000	0.0000	0.0000	

381/FIXOFFTB

**Figure 3-3, Fixture Offsets Table**

**Activating the Fixture Offsets Table**

To activate the Fixture Offsets Table:

1. In the Tool Page, press **OFFSETS (F1)**.

### Changing Fixture Offsets in the Table

There are two ways to change the values in the table, manually type a value or calibrate the fixture offset table entry to the machine's current location (shown on the axis display).

To change a fixture offset to a manually typed coordinate:

1. Highlight a Fixture Offset (row 1 through 9).
2. Press an axis key (**X**, **Y**, or **Z**).
3. Type a value and press **ENTER** to store the value in the table.

To calibrate the fixture offset table entry to the machine's current location:

1. Highlight a Fixture Offset (row 1 through 9).
2. Press **CalibX (F5)**, **CalibY (F6)**, or **CalibZ (F7)** to store the current machine position for the selected axis in the table.

### Resetting Absolute Zero (Part Zero)

Absolute Zero is the X0, Y0 position for absolute dimensions. A **SetZero** block sets the Absolute Zero Reference of one or more axes to a new position. Use **SetZero** in one of two ways: to reset X0 Y0 or to preset the current location to entered coordinates.

In axis presetting, non-zero XY values set the current machine position to the entered coordinates. In axis resetting, X0 and Y0 values set the current machine position as the new Absolute Zero Reference.

When the CNC executes the block, the X and Y values (zero or non-zero) in the graphic menu redefine Absolute Zero.

In [Figure 3-4, Executing a SetZero Block](#), diagram A shows Part Zero and tool position prior to a **SetZero** block. In this example, the operator programs a **SetZero** block with the following coordinates: **X2, Y-1**.

Diagram B shows Part Zero and tool position following the **SetZero** block. The coordinates at the tool position become **X2, Y-1**. This, in effect, moves Part Zero, as indicated.

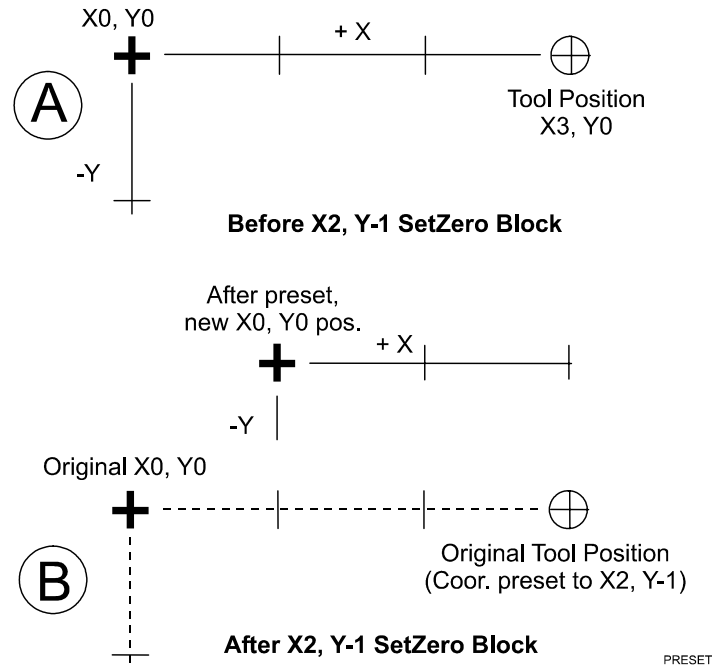

**Figure 3-4, Executing a SetZero Block**

Change Absolute Zero to cut more than one part with the same moves. Restore the location of the original X0, Y0 reference at the end of the program so that programmed part change positions do not move each time the program runs. Refer to **Figure 3-5**.

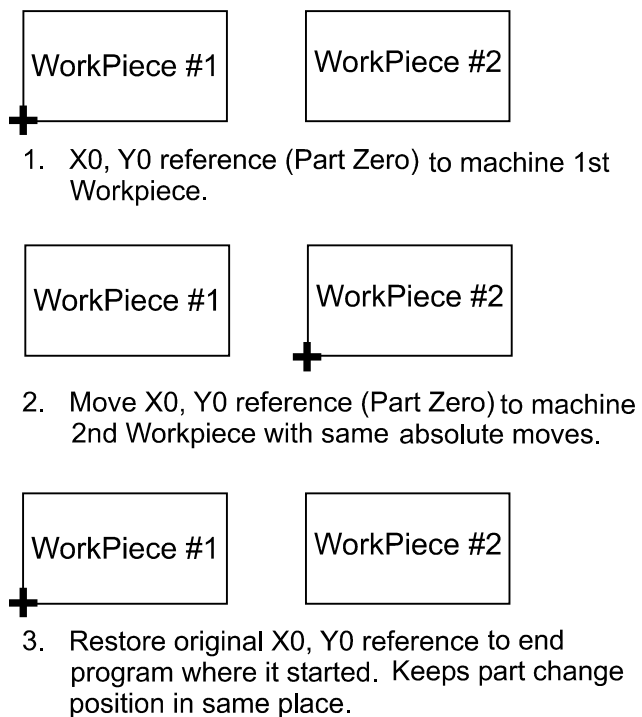

DUALPT

**Figure 3-5, Using SetZero in a Program**

When an axis entry field (**X**, **Y**, or **Z**) remains blank in a graphic menu, the CNC does not change the position of that axis. Refer to **Figure 3-6**.

**NOTE:** In most programs, the Z-axis position does not change. Changing the Z-axis position changes the Tool #0, Z0 position, which alters all existing tool-length offsets.

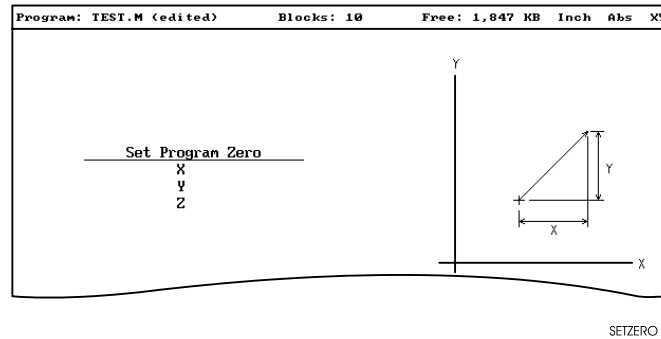

**Figure 3-6, Set Zero Graphic Menu**

To program a **SetZero** block:

1. In Edit Mode, press **Mill (F5)** to change the soft key labels.
2. Press **More (F7)** to display the pop-up menu.
3. Position the highlight to select **SetZero**, and then press **ENTER**. The **Set Program Zero Graphic** menu prompts for the absolute coordinates of the machine's current position.
4. Type the appropriate **X**, **Y**, and **Z** coordinates and press **ENTER** to add the block to the Program Listing.

### Programming a Plane Change

The CNC executes Arc moves and compensates for tool diameters in three different planes (**XY**, **YZ**, and **XZ**). By default, the CNC operates in the XY plane. Program a Plane block to change the CNC's active plane. Following moves in the XZ or YZ plane, program a second Plane block to return to the XY plane.

A Plane block also changes the active plane of the Program Editor. The Program Editor customizes Arc graphic menus for the active plane.

When a plane block is deleted from the Program Listing, the active plane of the Editor does not change.

To program a Plane block using hot keys:

1. In Edit Mode, press **9/PLANE**. The **SET PLANE** graphic menu prompts for plane selection.
2. Press the **+/-** key to change the selection to the desired plane. Press **ENTER** to add the block to the Program Listing.

To program a Plane block using soft keys:

1. In Edit Mode press **Mill (F5)** to display the Mill soft keys.
2. Press **More (F7)** to display the **More** pop-up menu.
3. Highlight **Plane** and press **ENTER**. The **SET PLANE** graphic menu prompts for plane selection.
4. Press **+/-** to change to the desired plane. Press **ENTER** to add the block to the Program Listing.

### Programming a Feedrate Change

A Feed block sets the feedrate for Line moves, arcs, and cycles that do not contain specifically programmed feedrates. Feed blocks also set the feedrate for modal moves. Add Feed blocks whenever necessary.

**NOTE:** A Feed block does not activate the Feed Mode.

To program a Feed block from the hot keys:

1. In Edit Mode, press **4/FEED** to display the **FEEDRATE** graphic menu.
2. Type the required feedrate and press **ENTER** to add the block to the Program Listing.

To program a Feed block from the soft keys:

1. In Edit Mode, press **Mill (F5)** to display the Mill soft keys.
2. Press **More (F7)** to display the **More** pop-up menu.
3. Highlight **Feed** and press **ENTER** to activate the **FEEDRATE** graphic menu.
4. Press **Save (F10)** or **ENTER** to add Feed block to the Program Listing.

### Programming a Spindle RPM

If your CNC has a programmable spindle RPM, you can set the RPM as follows:

To program an RPM block from the hot keys:

1. In Edit Mode, press the **°** (Decimal/RPM) key to display the **Spindle RPM** graphic menu.
2. Type the required spindle RPM and press **ENTER** to add the block to the Program Listing.

To program an RPM block from the soft keys:

1. In Edit Mode, press **Mill (F5)** to display the Mill soft keys.
2. Press **More (F7)** to display the **More** pop-up menu.
3. Highlight **RPM** and press **ENTER** to activate the **Spindle RPM** graphic menu.
4. Type the required RPM.
5. Press **Save (F10)** or **ENTER** to add RPM block to the Program Listing.

## Straight Moves

### Programming a Rapid Move

Rapid moves run at the CNC's Rapid rate and save time when positioning for a cut or a canned cycle.

Use Rapid moves to activate/deactivate tool diameter compensation and cutter compensation. Refer to **Figure 3-7**.

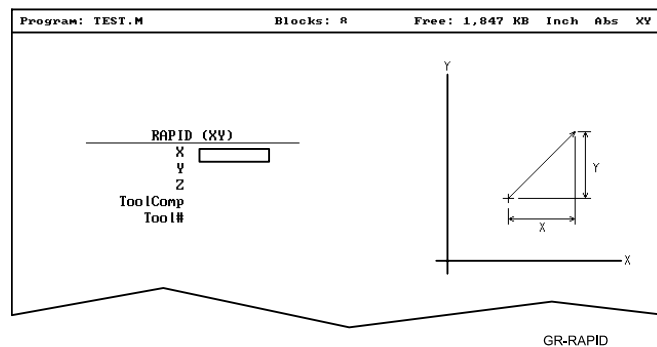

**Figure 3-7, Rapid Move Graphic Menu**

To program a Rapid move using hot keys:

1. In Edit Mode, press **1/RAPID** to activate the **RAPID (XY)** graphic menu.
2. Type the **X**, **Y**, and **Z** coordinates in the appropriate entry fields.
3. Press **+/-** to set **ToolComp** (optional) and press **ENTER**.

To program a Rapid move using soft keys:

1. In Edit Mode, press **Mill (F5)** to display the Mill soft keys.
2. Press **Rapid (F2)** to activate the **RAPID (XY)** graphic menu.
3. Type the appropriate values and settings in the labeled entry fields.



## Programming a Line Move

Straight-line moves run in Feed. Refer to **Figure 3-8**.

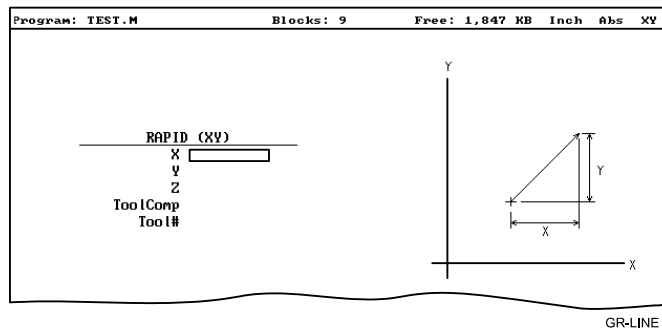

**Figure 3-8, Line Move Graphic Menu**

To program a Line move using hot keys:

1. In Edit Mode, press **2/LINE** to activate the **LINE (XY)** graphic menu.
2. Type the appropriate values and settings in the labeled entry fields.

To program a Line move using soft keys:

1. In Edit Mode, press **Mill (F5)** to change the soft key labels.
2. Press **Line (F3)** to display the **LINE (XY)** graphic menu.
3. Type the appropriate values and settings in the labeled entry fields.
4. With the last entry field highlighted, press **ENTER** to add the block to the Program Listing.

## Programming a Modal Move

A modal move is a straight move executed in the active Rapid or Feed Mode.

To program a Modal move:

1. In Edit Mode, press **X, Y, or Z**. The **MODAL MOVE** graphic menu prompts for the X, Y, and Z positions.
2. Type the required positions.
3. From the last field on the graphic menu, press **ENTER** or **Save (F10)** to add the modal move block (Xn Yn Zn) to the program.

**NOTE:** When using modal moves, be sure the CNC is in the required Rapid or Line Mode. The CNC executes Line Mode moves in Feed Mode.

## Line or Rapid Moves

Using the X, Y, or XY endpoints, the CNC can write Line or Rapid moves. The CNC calculates the missing endpoint(s). Define the move as part of a right triangle with the components identified as in **Figure 3-9**.

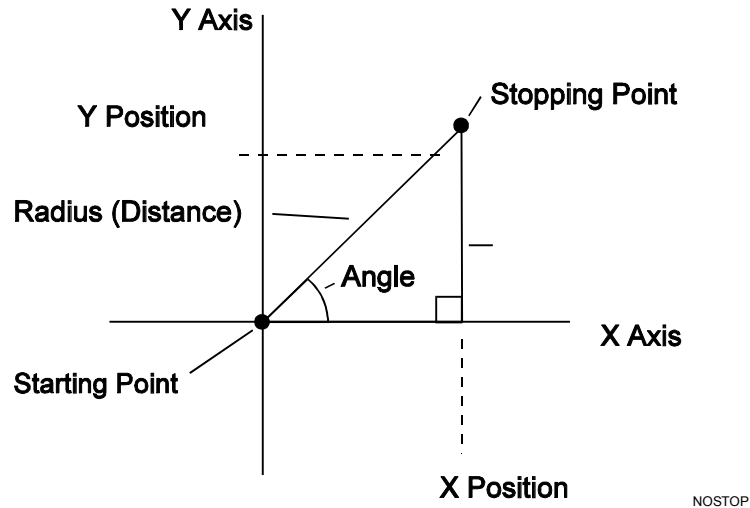

**Figure 3-9, Move Orientation**

The CNC can calculate move endpoints, given:

- Angle and radius
- X position and angle
- Y position and angle
- X position and radius
- Y position and radius

The **Rapid** and **Line** graphic menus are similar. However, the **Rapid** graphic menus do not contain **CornerRad** or **Feed** entry fields. Use either the Absolute or Incremental Mode.

### Programming a Move Using XY Location, Radii, or Angles

To program a move using a Line or Rapid block:

1. In Edit Mode, press **Mill (F5)** and select either **Rapid (F2)** or **Line (F3)**.

– or –

In Edit Mode, press **1/RAPID** or **2/LINE** to display the **RAPID (XY)** or **LINE (XY)** graphic menu.

2. Press **More. . . (F4)** to display the Template pop-up menu. Refer to **Figure 3-10**.

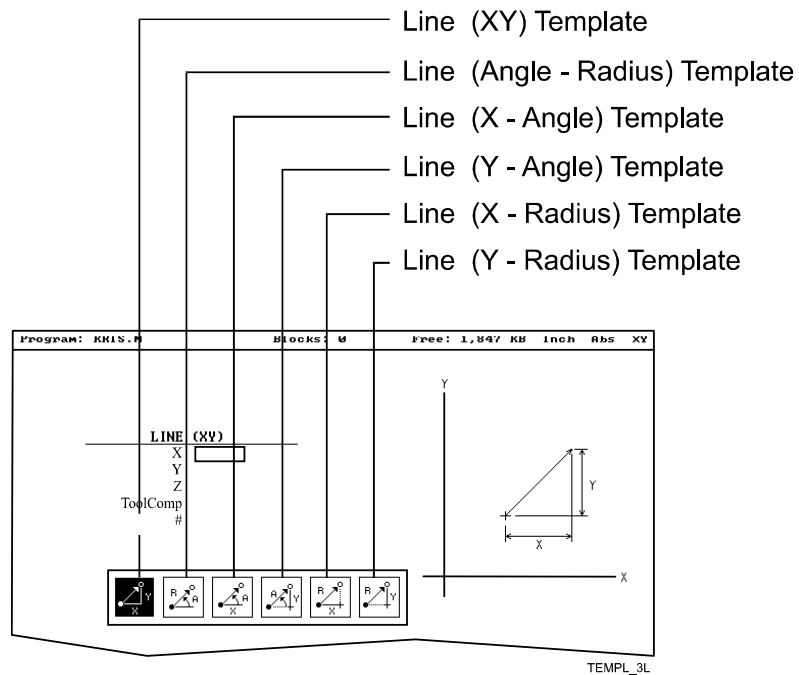

**Figure 3-10, Rapid/Line Template Pop-up Menu**

3. Highlight the appropriate template and press **ENTER** to display the graphic menu.
4. Type the required values/settings in the entry fields.

## Arcs

### Selecting the Plane for an Arc

The CNC executes Arcs in the XY plane by default. For an Arc in the XZ or YZ plane, program the plane change before the Arc move. The plane change customizes the Arc graphic menus for the required plane.

The graphic menus for moves in the XY, XZ, and YZ planes contain the same entry fields. Entry fields for selected plane positions require a value.

After a move in the XZ or YZ plane, return the CNC to the XY plane.

**NOTE:** To activate a new plane in the Program Editor, program a plane change block.

Program Arc moves:

- Using the endpoint and radius
- Using the center and endpoint
- Using the center and angle

### Programming an Arc Using an Endpoint and Radius

To define the **Endpoint - Radius Arc**, type the direction of the Arc, the endpoint, and the radius. The CNC cuts an Arc of the specified radius from the current position to the endpoint. You must correctly define the modal endpoint coordinates in the **Absolute** or **Incremental** Mode.

In the XY plane, if the Z-axis starting and end points differ, the arc is a helix.

Two Arcs can intersect any two points: an Arc with an included angle less than 180 degrees and an Arc with an included angle greater than 180 degrees. Refer to **Figure 3-11**.

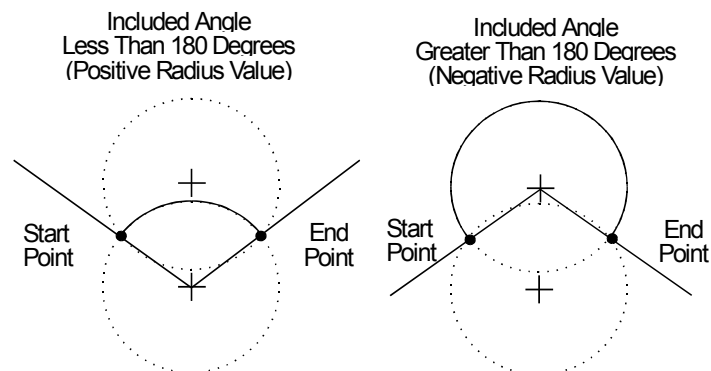

**Figure 3-11, Endpoint Radius Arc Types**

To program an Arc with an included angle less than 180 degrees, type a positive radius value. To program an Arc with an included angle greater

than 180 degrees, type a negative radius value. The CNC selects which Arc center to use, based on the sign of the typed value.

To program an Arc using an endpoint and radius, using hot keys:

1. In Edit Mode, press **3/ARC**. The **ARC (END POINT - RADIUS)** graphic menu prompts for labeled values.
2. Fill in the entry fields as labeled.

To program an Arc using an endpoint and radius, using soft keys:

1. In Edit Mode, press **Mill (F5)** to display the Mill secondary soft keys.
2. Press **Arc (F4)** to display the **ARC (END POINT - RADIUS)** graphic menu. Refer to **Figure 3-12**.

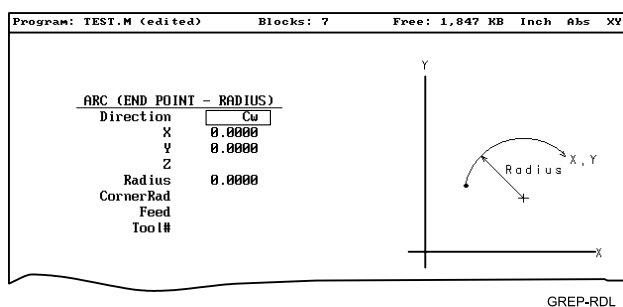

**Figure 3-12, ARC (END POINT - RADIUS) Graphic Menu**

3. Fill in the **ARC (END POINT - RADIUS)** entry fields:

- |                  |   |
|------------------|---|
| <b>Direction</b> | Specifies a clockwise ( <b>Cw</b> ) or counterclockwise ( <b>Ccw</b> ) direction. Press <b>+/-</b> to toggle the setting. Selection required. |
| <b>X</b>         | The X coordinate of the Arc endpoint. Value required.   |
| <b>Y</b>         | The Y coordinate of the Arc endpoint. Value required.   |
| <b>Z</b>         | The Z coordinate of the endpoint. Optional.   |
| <b>Radius</b>    | The radius of the Arc. Value required (positive or negative).   |
| <b>CornerRad</b> | Corner radius setting. Optional.  |
| <b>Feed</b>      | Feedrate. Optional.   |

### Programming an Arc Using the Center and Endpoint

**NOTE:** Use Center and Endpoint Arcs to cut helical threads.

To define the **Center - Endpoint Arc**, type the endpoint, arc center, and direction. The CNC cuts an Arc from the current position to the end point.

In Absolute Mode, the CNC measures the Arc center and endpoint from Absolute Zero. In Incremental Mode, the CNC measures the Arc center and end point from the starting position of the arc.

**NOTE:** Ensure that the required Absolute or Incremental Mode is active.

When the Z-axis start and end points differ in the XY plane, the Arc is a helix. The **Revs** value determines the number of rotations used to machine the helix.

The CNC calculates the radius from the specified starting point and Arc center. Therefore, the endpoint must lie along the Arc's path. If the endpoint does not lie along the Arc's path, the CNC will adjust the center or end point. Configure whether the CNC will adjust the center or endpoint in the Setup Utility. Endpoint is preferred. The machine builder sets the maximum arc circle center adjustment in the Setup Utility. If the error exceeds the setup tolerance, the CNC generates an error message.

To program a **Center - End Point Arc** using hot keys:

1. In Edit Mode, press **3/ARC** to display the **ARC (CENTER – END POINT)** graphic menu. Refer to **Figure 3-13**.

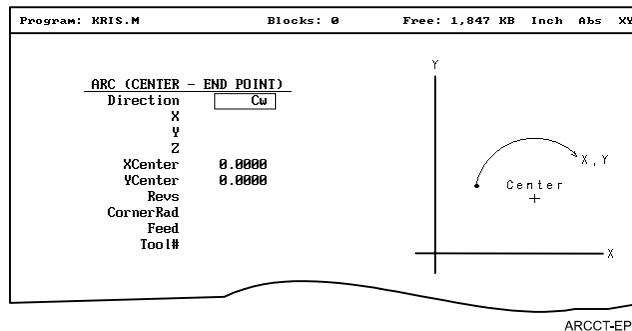
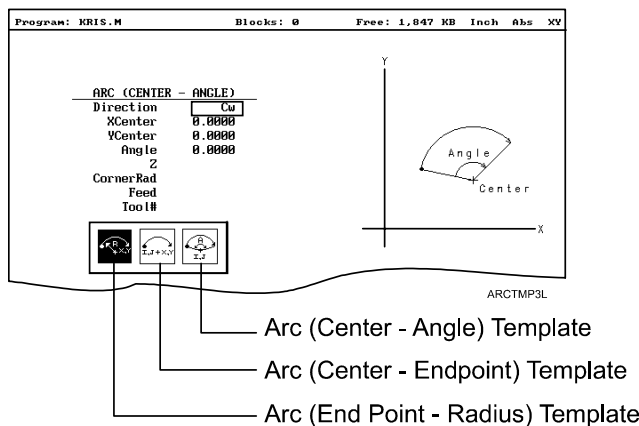

**Figure 3-13, ARC (CENTER – END POINT) Graphic Menu**

2. Press **More... (F4)** to display the Arc template pop-up menu. Refer to [Figure 3-14, Arc Template Pop-Up Menu](#).
3. Highlight the **Center – End Point** template and press **ENTER** to display the **ARC (CENTER – END POINT)** graphic menu.
4. Type the required values or settings in the entry fields.

To program a **Center – End Point Arc** using soft keys:

1. In Edit Mode, press **Mill (F5)** to display the Mill secondary soft keys.
2. Press **Arc (F4)** to display the **ARC (END POINT - RADIUS)** graphic menu.
3. Press **More... (F4)** to display the Arc Template pop-up menu. (Refer to **Figure 3-14**).



**Figure 3-14, Arc Template Pop-Up Menu**

4. Highlight the **Center – End Point** template and press **ENTER**. The **ARC (CENTER – END POINT)** graphic menu prompts for the labeled values.
5. Type the required values or setting in the following labeled entry fields:

<b>Direction</b>	Allows you to select a clockwise ( <b>Cw</b> ) or counterclockwise ( <b>Ccw</b> ) direction. Press <b>+/-</b> to toggle the setting. Selection required.
<b>X</b>	The X coordinate of the Arc end point. Optional.
<b>Y</b>	The Y coordinate of the Arc end point. Optional.
<b>Z</b>	The Z coordinate of the Arc end point. Optional.
<b>XCenter</b>	The X coordinate of the Arc center. Value required.
<b>YCenter</b>	The Y coordinate of the Arc center. Value required.
<b>Revs</b>	Number of revolutions from start position to endpoint. Optional.
<b>CornerRad</b>	Corner radius setting. Optional.
<b>Feed</b>	Feedrate. Optional.

### Programming an Arc Using the Center and the Included Angle

To define the **Center - Angle Arc**, type the arc center and the included angle. The CNC cuts the Arc from the present position until the Arc travels the specified number of degrees. The CNC calculates the radius, which is the distance between the start position and the center point.

Specify the appropriate Absolute or Incremental Mode for the angle and center point. Refer to **Figure 3-15** and **Figure 3-16**.

The direction (Cw/Ccw) of the Arc and the sign (+/-) of the angle control the path of the tool.

If the Z-axis starting and end points differ, the Arc will be a helix.

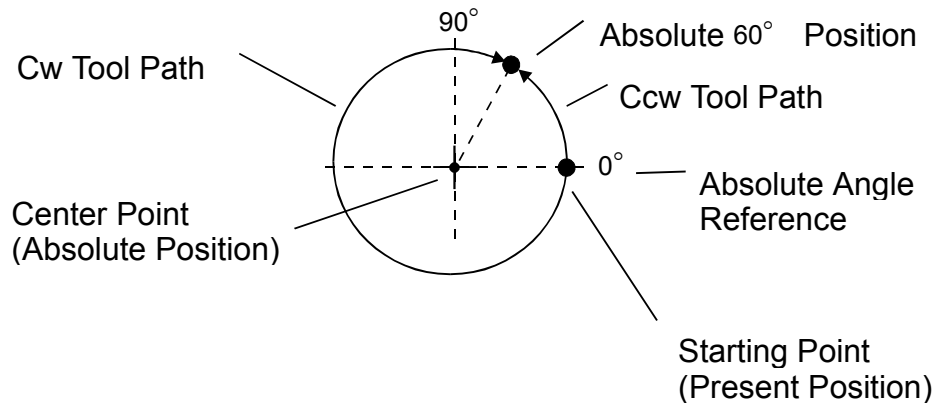

**Figure 3-15, Absolute Mode, Center - Angle Arc**

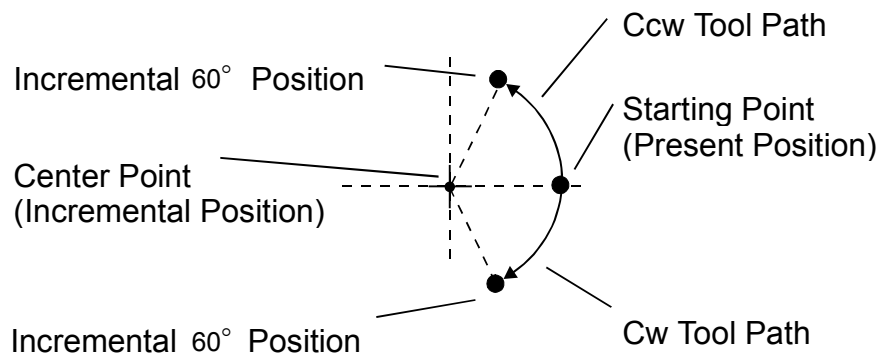

**Figure 3-16, Incremental Mode, Center - Angle Arc**



Refer to **Figure 3-17**.

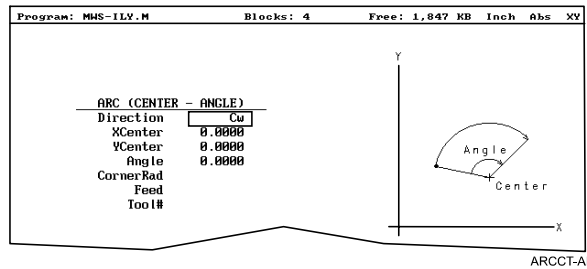

**Figure 3-17, Arc (Center - Angle) Graphic Menu**

To program an Arc using the center and the included angle using hot keys:

1. In Edit Mode, press **3/ARC** to display the **ARC (ENDPOINT - RADIUS)** graphic menu.
2. Press **More... (F4)** to display the Arc Template pop-up menu. (Refer to [Figure 3-14, Arc Template Pop-Up Menu.](#))
3. Highlight the **Center - Angle** template and press **ENTER** to display the **ARC (CENTER - ANGLE)** graphic menu.
4. Type the required values and settings in the entry fields.

To program an Arc using the center and the included angle using soft keys:

1. In Edit Mode, press **Mill (F5)** to activate the Mill secondary soft keys.
2. Press **Arc (F4)** to display the **ARC (END POINT - RADIUS)** graphic menu.
3. Press **More... (F4)** to display the Arc template pop-up menu. Refer to [Figure 3-14, Arc Template Pop-Up Menu.](#)
4. Highlight the **Center - Angle** template and press **ENTER** to display the **ARC (CENTER - ANGLE)** graphic menu.
5. Fill in the **ARC (CENTER - ANGLE)** entry fields:

<b>Direction</b>	Specifies a clockwise ( <b>Cw</b> ) or counterclockwise ( <b>Ccw</b> ) direction. Press <b>+/-</b> to toggle the setting. Selection required.
<b>XCenter</b>	The X coordinate of the Arc's center. Value required.
<b>YCenter</b>	The Y coordinate of the Arc's center. Value required.
<b>Angle</b>	Included angle of the Arc. Value required.
<b>Z</b>	The Z coordinate of the Arc endpoint. Optional.
<b>CornerRad</b>	Corner radius setting. Optional.
<b>Feed</b>	Feedrate. Optional.

## Programming M-Code Blocks

The CNC supports M-Code functions. Enable available M-Codes at installation. Refer to the machine builder's technical data to determine which M-Codes are available.

Some programmed events initiate the same functions activated using M-Codes. Refer to **Table 3-3** for a list of the most commonly used M-Code functions.

**Table 3-3, M-Code Functions**

<b>M Code</b>	<b>Programmed Event</b>	<b>Standard Function Usage (ref. EIA Standard RS 274-D)</b>
<b>M02</b>	EndMain block.	Stops spindle and coolant.
<b>M03</b>	MCode 3	Start <b>CW</b> spindle rotation.
<b>M04</b>	MCode 4	Start <b>CCW</b> spindle rotation.
<b>M05</b>	MCode 5	Stop spindle in normal manner.
<b>M08</b>	MCode 8	Turn coolant pump <b>ON</b> .
<b>M09</b>	MCode 9	Turn coolant pump <b>OFF</b> .

To program an **MCode** block:

1. In Edit Mode, press **MCode (F8)**. The Graphic menu prompts for the **MCode** number and **X, Y, Z** values.
2. Type the values and press **Save (F10)** or **ENTER** to add **MCode** block to the program.

**Dry Run M-Codes**

In Dry Run Mode, the machine axes (X, Y, and Z) move through the program without cutting into the work. The CNC disables coolant operation and the work may or may not be placed on the table.

Activate Dry Run Mode with M-Codes 105 and 106. Deactivate it with M107. Refer to **Table 3-4**. Dry Run feedrates are set in the Setup Utility. They are often set at greater speeds than conventional feedrates. You can set them at any desired rate.

**Table 3-4, Dry Run Mode M-Codes**

<b>M-Code</b>	<b>Function</b>	<b>Description</b>
<b>M105</b>	Dry Run Mode <b>ON</b> , all axes	Enables machine Z Dry Run Mode. Program runs at dry run feedrates specified in the Setup Utility.
<b>M106</b>	Dry Run Mode <b>ON</b> , no Z-axis	Enables machine Dry Run Mode. Program runs at dry run feedrates specified in the Setup Utility, without moving the Z-axis.
<b>M107</b>	Cancel Dry Run Mode	Cancels active Dry Run Mode.

## Section 4 - Programming Canned Cycles, Ellipses, and Spirals

### Drilling Cycles

**NOTE:** Program all blocks by filling in the entry fields of a Graphic Menu.

Drill cycles simplify the programming required for repetitive drilling, boring, and tapping operations. Select specific drill cycles from the Program Editor's **Drill (F3)** pop-up menu:

- Basic (drill cycle)
- [Pecking](#)
- [Boring](#)
- [Chip Break](#)
- [Tapping](#)
- [Drilling Off](#)
- [Pattern](#)
- [Bolt Hole](#)
- [Thread Mill](#)

Drill cycles are modal. When the CNC encounters a block for any type of Drill cycle, it executes that cycle at the endpoint of each subsequent move until it encounters a **DrillOff** block. To change drill cycle parameters between moves, program a new drill block.

#### Basic Drill Cycle

The Basic Drill Cycle is a modal operation. When the CNC receives a **BasicDrill** command, it performs the drilling operation at the endpoint of every subsequent block until it receives a **Drilling Off** block. To change Basic Drilling dimensions cancel the current cycle and program a new cycle.

During the cycle, the tool rapids to the **StartHgt**, then Z feeds to **ZDepth**. To provide clearance for the next move, at the end of the cycle, the tool rapids to **ReturnHgt**.

Program a **DrillOff** block to deactivate the cycle. You can program any number of patterns and moves before turning off the cycle.

To program a **BasicDrill** block:

1. In Edit mode, press **Drill (F3)** to display the **Drill** cycle pop-up menu.
2. Highlight **Basic** and press **ENTER** to display the **BASIC DRILLING** Graphic Menu. Refer to [Figure 4-1, BASIC DRILLING Graphic Menu](#).

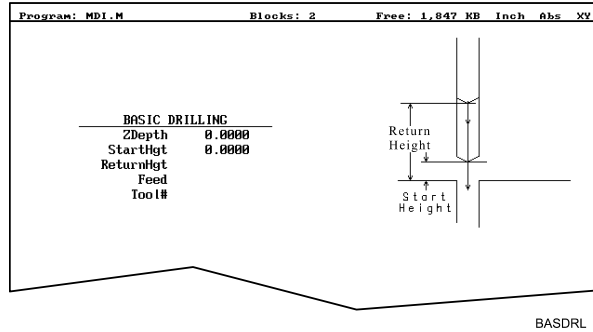

**Figure 4-1, BASIC DRILLING Graphic Menu**

3. Type the required values and settings in the entry fields. With the last entry field highlighted, press **ENTER**. The display clears and the CNC adds the **BasicDrill** block to the program listing.
4. Program subsequent moves to position the tool at the required drilling location(s). The CNC will drill a hole at the endpoint of every move.
5. After programming the last drill move, press **Drill (F3)** to display the **Drill** cycle pop-up menu.
6. Highlight **Drilling Off** and press **ENTER** to cancel the Drilling Mode.

**BASIC DRILLING** entry fields:

**ZDepth** The absolute depth of the finished hole. Value required.

**NOTE:** **ZDepth** must be lower than **StartHgt**. **StartHgt** is 0.100 inches (2.0 mm) above the work surface.

**StartHgt** The absolute Z position the CNC rapids to before feeding into the work. Value required.

**ReturnHgt** The absolute position to which the tool returns at the end of the cycle. Optional.

**Feed** Feedrate. Optional.

### Peck Drilling Cycle

Peck drilling is a modal operation. When the CNC receives a **PeckDrill** command, it peck-drills at the endpoint of every subsequent block until it receives a **Drilling Off** block. To change Peck Drilling dimensions, cancel the current **PeckDrill** cycle and program a new cycle.

The cycle starts when the CNC is in position. The tool rapids to the Z start height (**StartHgt**); feeds to the **Peck** depth; then rapids back to the **StartHgt**. This cycle repeats until the tool reaches **ZDepth**. At the end of the cycle, the tool rapids to the **ReturnHgt** to provide clearance for the next move.

To program a Peck Drilling cycle:

1. In Edit mode, press **Drill (F3)** to display the **Drill** cycle pop-up menu.
2. Highlight **Pecking** and press **ENTER** to display the **PECK DRILLING** Graphic Menu. Refer to **Figure 4-2**.

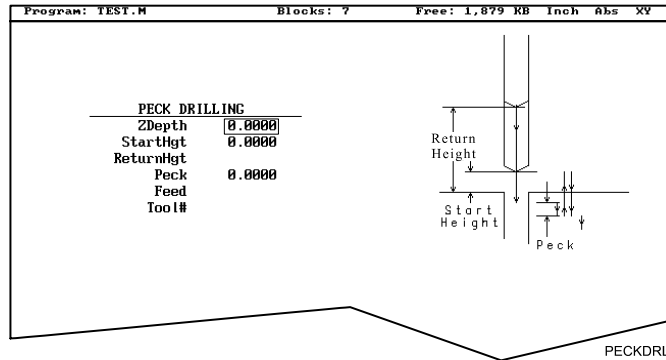

**Figure 4-2, PECK DRILLING Graphic Menu**

3. Type the required values and settings in the entry fields. With the last entry field highlighted, press **ENTER**. The Display clears and the CNC adds the **PeckDrill** block to the program listing.
4. Program subsequent moves to position the tool at the required drilling location(s). The CNC will drill a hole at the endpoint of every move.
5. After programming the last drill move, press **Drill (F3)** to display the **Drill** cycle pop-up menu.
6. Highlight **Drilling Off** and press **ENTER** to cancel the Drilling Mode.

**PECK DRILLING** entry fields:

**ZDepth** Absolute depth of the finished hole. Value required.

**NOTE:** **ZDepth** must be lower than **StartHgt**. **StartHgt** is 0.100 inches (2.0 mm) above the work surface.

**StartHgt** Absolute Z position the CNC rapids to before feeding into work. Value required.

**ReturnHgt** Absolute position the tool returns to at the end of the cycle. Optional.

**Peck** Depth drilled in each peck. Value required.

### Boring Cycle

Boring is a modal operation. When the CNC encounters a **Boring** block it executes a Boring Cycle at the endpoint of every subsequent move until it sees a **Drilling Off** block. To change Boring Cycle dimensions between moves, deactivate the cycle and program a new boring block.

The cycle starts when the CNC is in position. The tool rapids to the **StartHgt**, feeds to **ZDepth**, then feeds back to **StartHgt**. At the end of the cycle, the tool moves to **ReturnHgt** to provide clearance for the next move.

When running a **Dwell** block, the CNC pauses at **ZDepth** for the indicated time period (in seconds). **Dwell** resolution is 0.1 sec. When you type 0.0 sec., the CNC dwells until manually restarted.

To program a Boring cycle:

1. In Edit mode, press **Drill (F3)** to display the **Drill** cycle pop-up menu.
2. Highlight **Boring** and press **ENTER** to display the **BORING CYCLE** Graphic Menu. Refer to **Figure 4-3**.

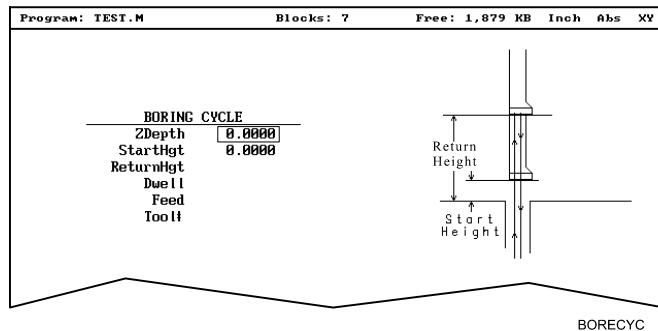

**Figure 4-3, BORING CYCLE Graphic Menu**

**BORING CYCLE** entry fields:

**ZDepth** Absolute depth of the finished hole. Value required.

**NOTE: ZDepth** must be lower than **StartHgt**. **StartHgt** is 0.100 inches (2.0 MM) above the work surface.

**StartHgt** Absolute Z position the CNC rapids to before feeding into work. Value required.

**ReturnHgt** Absolute position to which the tool returns at the end of the cycle. Optional.

**Dwell** Length of time for pause at **ZDepth**.

**Feed** Feedrate. Optional.

3. Type the required values and settings in the entry fields. With the last entry field highlighted, press **ENTER**. The display clears and the CNC adds **Boring** block to the program listing.
4. Program subsequent moves to position the work at the required boring locations. The CNC executes the Boring Cycle at the endpoint of every move.
5. After programming the last boring position, press **Drill (F3)** to display the **Drill** cycle pop-up menu.
6. Highlight **Drilling Off** and press **ENTER** to cancel the cycle.

**Chip Break Cycle**

The Chip Break Cycle is modal. Once the CNC encounters a **ChipBreak** block, it executes the Chip Break Cycle at the endpoint of each block until it sees a **Drilling Off** block. To change Chip Break values between moves, deactivate the cycle and program a new one.

The cycle starts when the CNC is in position. The tool rapids to the **StartHgt**, feeds to the **FirstPeck**, retracts 0.02 inches [0.4 mm (default value)], then feeds to the next peck. Retract moves occur at the end of each peck in order to break the chip. This cycle repeats until the tool reaches **ZDepth**. At the end of the cycle, the tool moves to **ReturnHgt** to provide clearance for the next move.

Type a **PeckDecr** value to decrement the depth of each peck by the specified amount. The **MinPeck** sets the minimum peck the cycle can decrement. A **ChipBrkInc** is the size of the retract move that breaks the chip.

Peck to the **RetractDep**, retract to the **StartHgt**, then peck to the next **RetractDep** increment. The first full retract occurs one **RetractDep** increment after the first peck.

To program a Chip Break cycle:

1. In Edit Mode, press **Drill (F3)** to display the **Drill** cycle pop-up menu.
2. Highlight **Chip Break** and press **ENTER** to display the **CHIP BREAKING CYCLE** Graphic Menu. Refer to **Figure 4-4**.

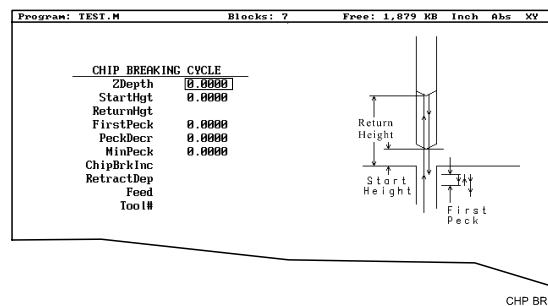

**Figure 4-4, CHIP BREAKING CYCLE Graphic Menu**



### CHIP BREAKING CYCLE entry fields:

**ZDepth** Absolute depth of the finished hole. Value required.

**NOTE:** **ZDepth** must be lower than **StartHgt**. **StartHgt** is 0.100 inches (2.0 mm) above the work surface.

**StartHgt** Absolute Z position to which the CNC rapids before feeding into work. Value required.

**ReturnHgt** Absolute position to which the tool returns at the end of the cycle. Optional.

**FirstPeck** Absolute depth drilled in each peck. Value required.

**PeckDecr** Amount to subtract from previous peck (positive dimension). Value required.

**MinPeck** Smallest peck allowed. Value required.

**ChipBrkInc** Size of chip break retract. Optional.

**RetractDep** Z increment before full retract. Optional.

3. Type the required values and settings in the entry fields. With the last entry field highlighted, press **ENTER**. The display clears and the CNC adds the **Chip Break** block to the program listing.
4. Program the drilling location(s). The CNC will drill a hole at the endpoint of every move until it receives the **Drilling Off** command.
5. Program the **Drilling Off** command. After programming the last drill move, press **Drill (F3)** to display the **Drill** cycle pop-up menu.
6. Highlight **Drilling Off** and press **ENTER** to add the **DrillOff** block to the program Listing.

### Tapping Cycle

The Tapping Cycle is available only on machines equipped with spindle RPM control and M-Codes (M3, M4, and M5).

In order for the cycle to operate, you must program a **Spindle RPM** block. During execution, the CNC uses the **Spindle RPM** programmed value and the programmed threads per inch (or pitch) value from the block to calculate the proper feedrate for tapping.

When the cycle runs the CNC rapids to the **StartHgt** and feeds to the **ZDepth**. The spindle stops and reverses direction to retract the tool from the hole. At **ReturnHgt**, the spindle stops and changes back to the original direction in preparation for the next programmed move.

Use the Tapping Cycle with any available pattern. A **Drilling Off** block cancels the cycle.

**NOTE:** The system supports spindle FWD, REV, OFF (M3, M4, M5), and spindle RPM control. At machine setup the machine builder determines which M-Codes to install.

To program a **Tapping** block:

1. In Edit mode, press **Drill (F3)** to display the **Drill** cycle pop-up menu.
2. Highlight Tapping and press **ENTER** to display the **TAPPING CYCLE** Graphic Menu. Refer to **Figure 4-5**.

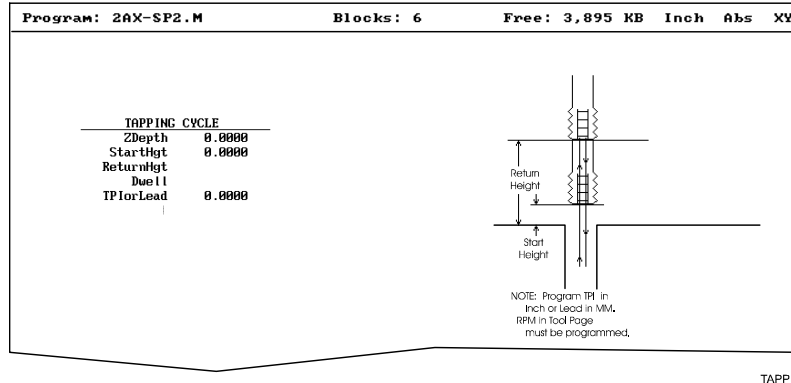

**Figure 4-5, Tapping Cycle Graphic Menu**

**TAPPING CYCLE** entry fields:

**ZDepth** Absolute depth of the tapped threads. Value required.

**NOTE: ZDepth** must be lower than **StartHgt**. **StartHgt** is 0.100 inches (2.0 mm) above the work surface.

**StartHgt** Absolute Z position to which the CNC rapids before feeding into work. Value required.

**ReturnHgt** Absolute position to which the tool returns at the end of the cycle. Optional.

**TPIorLead** TPI in Inch or Lead in millimeters. Value required.

**Dwell** Length of time for pause at **Zdepth** and **StartHgt**. Optional.

3. Type the required settings and values in the entry fields. With the last entry field highlighted, press **ENTER** to clear the display and add the new tapping cycle block to the program listing.
4. Program subsequent moves to position the location of the tapped holes. The CNC will tap a hole at the endpoint of every move until it receives a **Drilling Off** command.
5. To program a **Drilling Off** block, press **Drill (F3)** to display the **Drill** cycle pop-up menu.
6. Highlight **Drilling Off** and press **ENTER** to display the **Drill Off** block in the program listing.

### Drill Pattern

The Pattern Cycle instructs the CNC to execute a pattern of regularly spaced moves. Locate a Pattern Cycle between a Drill Cycle and a **DrillOff** block. The CNC executes the Drill Cycle at every endpoint in the pattern.

In a Pattern Cycle, type a size, location, spacing, Tool #, and rotation angle of the pattern.

To program a Drill Pattern cycle:

1. In Edit Mode, press **Drill (F3)** to display the **Drill** cycle pop-up menu.
2. Select **Pattern** from the **Drill** pop-up menu and press **ENTER** to display the **PATTERN DRILL** Graphic Menu. Refer to **Figure 4-6**.

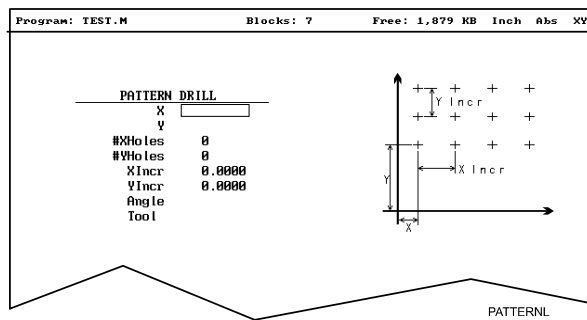

**Figure 4-6, Pattern Drill Graphic Menu**

**PATTERN DRILL** entry fields:

- X** X coordinate of corner hole. If no entry made, CNC puts corner hole at present location. Optional.
- Y** Y coordinate of corner hole. If no entry made, CNC puts corner hole at present location. Optional.
- #XHoles** Number of rows that lie along the X-axis. Must type value greater than 0. Value required.
- #YHoles** Number of rows that lie along the Y-axis. Must type value greater than 0. Value required.

**NOTE:** Type **1** in either the **#XHoles** or the **#YHoles** field to drill a single row or column.

- Xincr** X-axis increment (spacing) of holes. Value required.
- Yincr** Y-axis increment (spacing) of holes. Value required.
- Angle** This value rotates the pattern. The XY corner hole is the pivot, the rotation angle is the number of degrees counterclockwise from the X-axis or 3 o'clock position.

**NOTE:** Use a **Drilling Off** block to cancel cycle.

3. Type the required values and settings in the entry fields.

### Bolt Hole Pattern

The Bolt Hole Cycle instructs the CNC to run a series of moves with endpoints that form a circular pattern. At each of these endpoints, you can run a previously programmed Drill Cycle.

You should first program a Drill Cycle to describe the hole being drilled. Then follow the Drill Cycle by one or more moves, patterns, or Bolt Hole cycles to position the CNC for the Drill Cycle. A **DrillOff** block cancels the cycle.

To program a Bolt Hole Cycle:

1. In Edit Mode, press **Drill (F3)** to display a pop-up menu.
2. Select **Bolt Hole** from the pop-up menu and press **ENTER** to display the **BOLTHOLE DRILL** Graphic Menu. Refer to **Figure 4-7**.

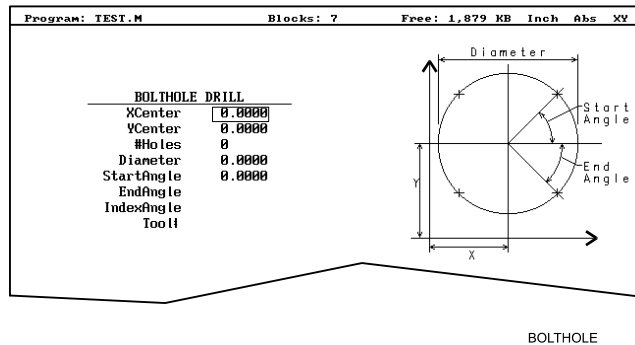

**Figure 4-7, BOLTHOLE DRILL Graphic Menu**

3. Type the following required values and settings in the entry fields:

**XCenter** Absolute X center of the bolt hole pattern. If no entry is made, the CNC puts the center of the Bolt Hole pattern at X0. Value required.

**YCenter** Absolute Y center of the bolt hole pattern. If no entry is made, the CNC puts the center of the Bolt Hole pattern at Y0. Value required.

**NOTE:** Use absolute center point coordinates whenever possible.

**#Holes** Number of equally spaced holes in the circular pattern. Value required.

**Diameter** Diameter of the circular pattern. Value required.

**StartAngle** The number of degrees (from the 3 o'clock position) to the first hole. Value required.

**EndAngle** The number of degrees (from the 3 o'clock position) to the last hole. Optional.

**IndexAngle** The number of degrees that the 3 o'clock reference position rotates around the center (rotates entire pattern).

**NOTE:** Use a **Drilling Off** block to cancel the cycle.

### Thread Milling Cycle

Thread Milling Cycle simplifies the programming required to mill a thread. It will cut inside or outside, up or down, straight or tapered right or left hand, and inch or metric. Tool must be position at center of hole or boss. This can be done either by positioning before putting cycle in the program or in the cycle.

Cutter compensation is built into cycle, so cutter diameter must be entered into tool table correctly.

**Xcenter**, **Ycenter**, **RoughFeed**, **FinFeed**, and **TaperAng** are all optional Input; all other parameters must be programmed. If the feed rates are not programmed, the CNC will use last feed rate used.

Cycle will always take the final pass twice. **Diameter** is always the major diameter of thread. Inside diameter is at finished depth and outside diameter is the diameter of boss.

To program a Thread Milling Cycle:

1. In Edit Mode, press **Drill (F3)** to display a pop-up menu.
2. Select **Thread Mill** from the pop-up menu, and press **ENTER** to display the **Thread Mill** Graphic Menu. Refer to **Figure 4-8**.

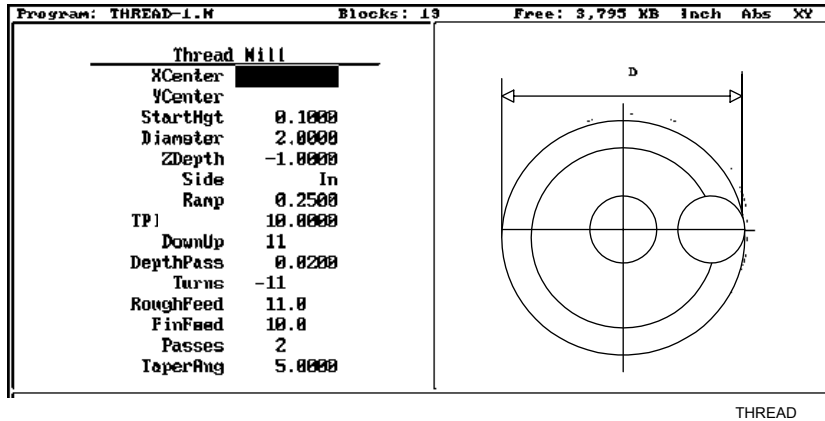

**Figure 4-8, Thread Mill Graphic Menu**

3. Enter the following required values and settings in the **Thread Mill** entry fields:

**XCenter** X coordinate of the center of the thread. If no coordinate is entered, the CNC puts the center of thread at X0. Optional.

<b>YCenter</b>	Y coordinate of the center of the thread. If no coordinate is entered, the CNC puts the center of the thread at Y0. Optional.
<b>StartHgt</b>	Absolute Z position to which the CNC rapids before feeding into work. Value required.
<b>Diameter</b>	Diameter of the thread. Inside root diameter of thread, outside major diameter. Value required.
<b>ZDepth</b>	Absolute depth that the cut will start. This can be above the top or down below the top according to how the thread is being cut. Value required.
<b>Side</b>	Inside or outside. Value required.
<b>Ramp</b>	Size of radius moving into start of thread. Value required.
<b>TPIorLead</b>	Threads per inch (TPI) or lead of thread. Value required.
<b>DownUp</b>	Number of turn required and + or – to give direction of Z movement. Number of turn will depend on type of cutter used, if multi tooth or single tooth cutter. The <b>TPIorLead</b> and <b>DownUp</b> will establish the distance to move in the Z-axis. Value required.
<b>Turns</b>	Number of turns around the part required to run a spiral. <b>CCW –</b> or <b>CW +</b> gives the direction of the arc. Value required.
<b>RoughFeed</b>	Feedrate for roughing. Optional.
<b>FinFeed</b>	Feedrate for the finish pass. Optional.
<b>Passes</b>	Number of cuts to be taken. Determines the start diameter. Value required.
<b>TaperAng</b>	Angle on one side of the thread. Not the included angle. Optional.

**Sample Thread Program**

This program will cut a 10 TPI thread starting at the bottom of the hole with a single pitched toothed cutter, 1.5 diameter taking 4 cuts plus a finish cut. Cutter will cut counter clockwise with a ramp in of 0.25 inch.

```

Dim Abs
Tool# 1
Rapid      X 1.0000 Y 1.0000
Rapid      Z 0.1000
ThreadMill StartHgt 0.1000 Diameter 1.5000 ZDepth -1.0000 Side In
Ramp 0.2500 TPIorLead 0.1000 DownUp 11 DepthPass 0.0100 Turns
11 RoughFeed 20.0 FinFeed 10.0 Passes 4
Rapid      Z 3.0000
EndMain
    
```

## Pocket Cycles

**NOTE:** Program all blocks by filling in the entry fields of a Graphic Menu.

Pocket canned cycles simplify the programming of repetitive moves required to mill out pockets. Select the pocket-canned cycles from the Program Editor **Pocket (F4)** pop-up menu. Refer to **Figure 4-9**.

**NOTE:** Programming a **Tool#** in a pocket cycle automatically activates the necessary tool compensation for that cycle.



**Figure 4-9, Pocket Pop-up Menu**

Select specific pocket cycles from the Program Editor's Pocket (**F4**) pop-up menu:

- [Facing Cycle](#)
- [Rectangular Profile Cycle](#)
- [Circular Profile Cycle](#)
- [Rectangular Pocket Cycle](#)
- [Circular Pocket Cycle](#)
- [Frame Pocket Cycle](#)
- [Hole – Mill Cycle](#)
- [Irregular Pocket Cycle](#)
- [Mold Rotation](#)
- [Elbow Milling Cycle](#)
- [Pockets with Islands](#)

### Facing Cycle

Facing cycles simplify the programming required to face the surface of a part.

Execution begins one tool radius from the start point. The selected step-over determines the approach axes.

**NOTE:** A **ZDepth** entry is not necessary if you program only one level plus finish stock.

Facing cycles can start in any corner of the surface and cut in any direction, depending on the sign (+/-) of the **Length** and **Width** values. Program a slightly oversized **Length** and **Width** to ensure complete facing of the surface.

At the end of the cycle, the tool rapids to **StartHgt**, then rapids back to the start position. Refer to **Figure 4-10**.

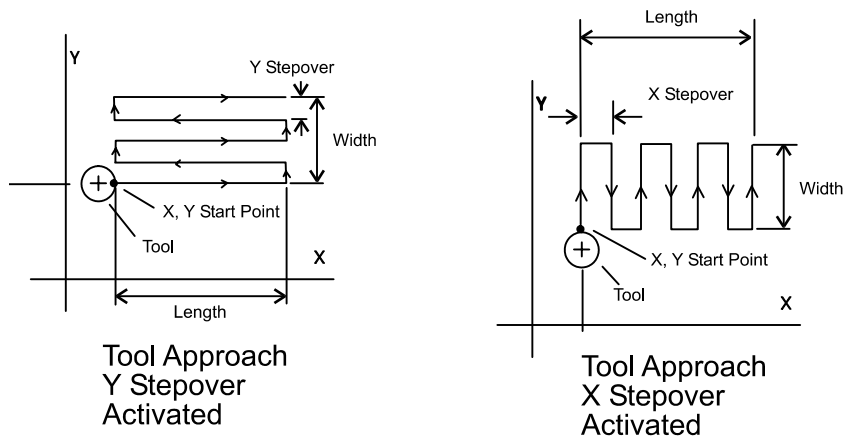

**Figure 4-10, Face Cycle Tool Approach**

To program a Facing cycle:

1. In Edit Mode, press **Pocket (F4)** to display a pop-up menu.
2. Move the highlight to select **Face** and press **ENTER** to display the **FACE POCKET** Graphic Menu. Refer to **Figure 4-11**.

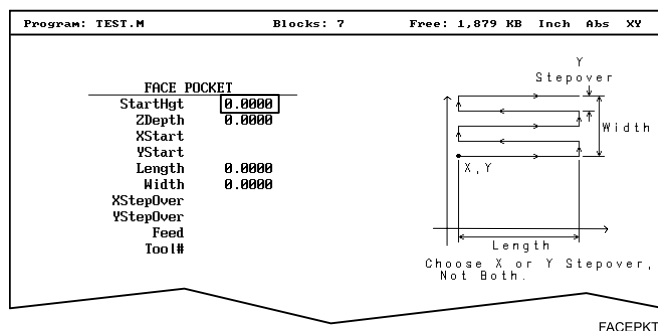

**Figure 4-11, FACE POCKET Graphic Menu**



**NOTE:** **ZDepth** must be lower than **StartHgt**. **StartHgt** is 0.100 inches (2.0 mm) above the work surface.

**FACE POCKET** entry fields:

<b>ZDepth</b>	Absolute depth of the finished surface. Value required.
<b>StartHgt</b>	Absolute Z position the CNC rapids to before feeding into work. Value required.
<b>XStart</b>	X coordinate of the starting point. Optional.
<b>YStart</b>	Y coordinate of the starting point. Optional.

**NOTE:** Type the required absolute **XStart** and **YStart** coordinates when possible.

<b>Length</b>	X-axis length to be faced. Value required.
<b>Width</b>	Y-axis length to be faced. Value required.
<b>XStepover</b>	Width of cut in the X-axis direction. When no value is typed, the CNC defaults to 70% of the active tool radius. Maximum step-over permitted is 70% of the active tool radius.

**NOTE:** Type either an **XStepover** or **YStepover**. Do not type both.

<b>YStepover</b>	Width of cut in the Y-axis direction. When no value is typed, the CNC defaults to 70% of the active tool radius. Maximum step-over permitted is 70% of the active tool radius.
------------------	--

**NOTE:** The Program Editor inadvertently will allow you to write a block containing a **Stepover** value greater than 70% of the active tool radius. To reveal this type of error, test the program in the Draw Graphics Mode.

3. Type the required values and settings in the entry fields.

### Rectangular Profile Cycle

The Rectangular Profile Cycle cleans up the inside or outside profile of a rectangle. When this cycle runs, the CNC rapids to the Ramp #1 starting position, rapids to **StartHgt**, then feeds to the depth of the first cut.

The machine feeds into the profile along Ramp #1, cuts the rectangle to the **Length** and **Width** specified, and then ramps away from the work along Ramp #2.

When cutting an inside profile, the **RECTANGULAR PROFILE** Graphic Menu displays ramp moves. Refer to **Figure 4-12**.

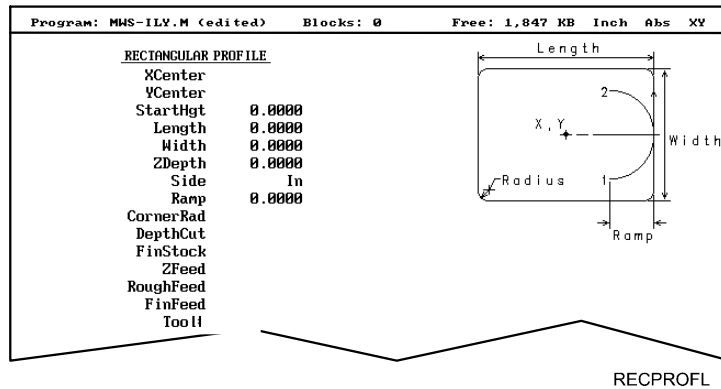

**Figure 4-12, RECTANGULAR PROFILE Graphic Menu**

When cutting an outside profile, the tool ramps into the profile along Ramp #1 and away from the profile along Ramp #2, as shown in **Figure 4-13**.

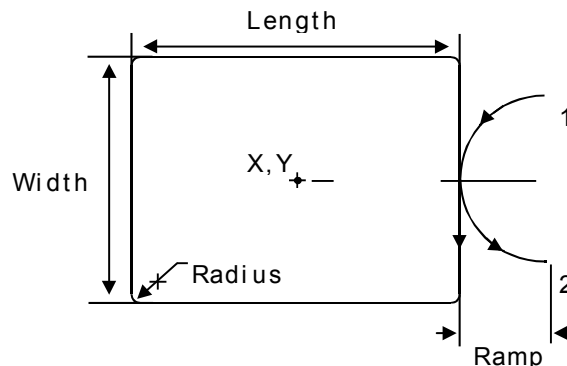

**Figure 4-13, Outside Profile Ramp Moves**

The Rectangular Profile Cycle automatically compensates for tool diameter. Activate the correct tool diameter before or within the **ProfRect** block.

When you type a **DepthCut** value, the CNC executes the number of passes required to get from the **StartHgt** to the **ZDepth**, cutting the **DepthCut** on each pass.

When you type a **FinStock** value, the CNC leaves the specified stock on the profile and depth for a finish pass. The CNC cuts the rectangle to the **Length**, **Width**, and **ZDepth** dimensions on the finish pass. Type a negative **FinStock** to leave the finish stock without making a finish pass.

When you do not type a **RoughFeed** or **FinFeed**, the CNC executes feed moves at the current feedrate. **RoughFeed** controls the feedrate of the roughing cycle. **FinFeed** controls the feedrate of the finishing cycle.

To program a Rectangular Profile cycle:

In Edit Mode, press **Pocket (F4)** to display the **Pocket** pop-up menu.

1. Highlight **Rect.Profile** and press **ENTER**. The **RECTANGULAR PROFILE** Graphic Menu prompts for labeled values.
2. Fill in the **RECTANGULAR PROFILE** entry fields labeled as follows:
  - XCenter** X coordinate of the center. If no coordinate is typed, the CNC centers the pocket at its present position. Optional.
  - YCenter** Y coordinate of the center. If no coordinate is typed, the CNC centers the pocket at its present position. Optional.
  - StartHgt** The absolute Z position to which the CNC rapids before feeding into the work. Value required.

**NOTE:** **StartHgt** is 0.100 inches (2.0 mm) above the work surface. **ZDepth** must be lower than **StartHgt**.

<b>Length</b>	Finished length of rectangle. Value required.
<b>Width</b>	Finished width of rectangle. Value required.
<b>ZDepth</b>	Absolute depth of the finished profile. Value required.
<b>Side</b>	Toggles cutting mode between the inside (In) or outside (Out) of the profile. Press +/- to toggle the selection. Selection required.
<b>Ramp</b>	Radius of the ramping moves. Value required.
<b>CornerRad</b>	Corner radius setting. If you type a negative value, both direction of cut and the starting and endpoints reverse. Optional.
<b>DepthCut</b>	Z-axis increment used for each pass. Optional.
<b>FinStock</b>	Amount of stock left by the machine before the finish pass. Default: <b>0</b> . If you type a negative value, the CNC leaves the stock without making a finish pass. Optional.
<b>ZFeed</b>	Z-axis feedrate. Optional.

**RoughFeed** Rough pass feedrate. Optional.  
**FinFeed** Finish pass feedrate. Optional.

**Circular Profile Cycle**

The Circular Profile Cycle cleans up the inside or outside profile of an existing circle. Refer to **Figure 4-14**.

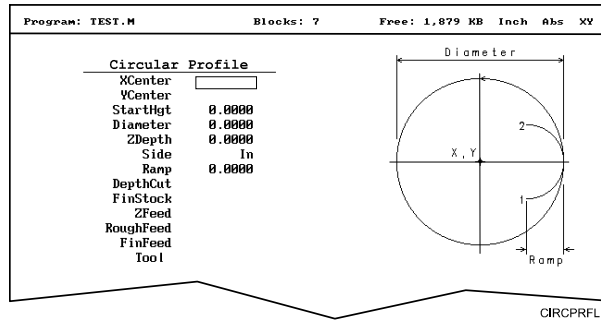
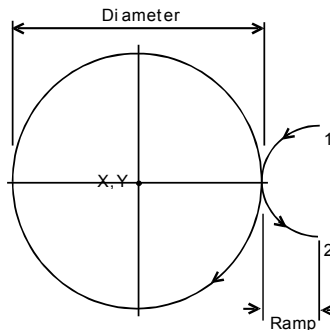

**Figure 4-14, CIRCULAR PROFILE Graphic Menu**

When executed, the CNC rapids to Ramp#1 starting position, rapids to **StartHgt**, then feeds to the depth of the first cut.

The machine feeds into the profile along Ramp #1, cuts the circle to the **Diameter** specified, and then ramps away from the work along Ramp #2.

When cutting an outside profile, the tool ramps into the work along Ramp #1 and away from the work along Ramp #2 as shown in **Figure 4-15**.



**Figure 4-15, Ramp Position for Outside Profile**

The Circular Profile Cycle automatically compensates for tool diameter. Activate the correct tool diameter before or within the **ProfCirc** block.

If you type a **DepthCut**, the CNC executes the number of passes required to get from the **StartHgt** to the **ZDepth**, cutting to the **DepthCut** on each pass.

When you type a **FinStock** value, the CNC leaves the specified stock on the profile and depth for a finish pass. The CNC finishes to the typed diameter on the finish pass. Type a negative **FinStock** to leave the finish stock without making a finish pass.

If you do not type a **RoughFeed** or **FinFeed**, the CNC executes feed moves at the current feedrate. **RoughFeed** controls feedrate of the roughing cycle. **FinFeed** controls the feedrate of the finishing cycle.

To program a Circular Profile cycle:

1. In Edit Mode, press **Pocket (F4)** to display the **Pocket** pop-up menu.
2. Highlight **Circ.Profile** and press **ENTER** to display the **CIRCULAR PROFILE** Graphic Menu. Refer to [Figure 4-14, CIRCULAR PROFILE Graphic Menu](#).

3. Fill in the **CIRCULAR PROFILE** entry fields:

<b>XCenter</b>	X coordinate of the center. Default: present position. Optional.
<b>YCenter</b>	Y coordinate of the center. Default: present position. Optional.
<b>StartHgt</b>	Absolute Z position to which the CNC rapids before feeding into work. Value required.

**NOTE:** **StartHgt** is 0.100 inches (2.0 mm) above the work surface. **ZDepth** must be lower than **StartHgt**.

<b>Diameter</b>	Finished diameter of circle. If you type a negative value, both the direction of cut and the starting and endpoints reverse. Value required.
<b>ZDepth</b>	Absolute depth of the finished profile. Value required.
<b>Side</b>	Selection for cutting on the inside of the profile (In) or the outside (Out). Press <b>+/-</b> to toggle the selection. Selection required.
<b>Ramp</b>	Radius of the ramp into and away from the cut. Value required (0 value allowed).
<b>DepthCut</b>	Z-axis increment used for each pass. Optional.
<b>FinStock</b>	Amount of stock left by the machine before the finish pass. Default: 0. Type a negative value to leave the stock without making a finish pass. Optional.
<b>ZFeed</b>	Z-axis feedrate. Optional.
<b>RoughFeed</b>	Rough pass feedrate. Optional.
<b>FinFeed</b>	Finish pass feedrate. Optional.

## Rectangular Pocket Cycle

Rectangular Pocket cycles simplify the programming required to mill out rectangular pockets. When executed, the CNC rapids to the center of the lower left radius, rapids to the **StartHgt**, then ramps into the work toward the narrow center of the pocket. From the pocket center, the CNC mills increasingly larger rectangles until it reaches the specified **Length** and **Width**.

The Rectangular Pocket Cycle automatically compensates for tool diameter. Activate the correct tool diameter before the **RectPock** block.

If you type **DepthCut**, the CNC executes the number of passes required to get from the **StartHgt** to the **ZDepth**, cutting the **DepthCut** on each pass.

Use **FinStock** to leave the specified stock on the profile and depth for a finish pass. The CNC cuts the rectangle to the **Length**, **Width**, and **ZDepth** dimensions on the finish pass. Type a negative **FinStock** to leave the finish stock without adding a finish pass.

If you do not type a **RoughFeed** or **FinFeed** value, the CNC executes feed moves at the current feedrate. **RoughFeed** controls the feedrate of the roughing cycle. **FinFeed** controls the feedrate of the finishing cycle.

To program a Rectangular Pocket cycle:

1. In Edit Mode, press **Pocket (F4)** to display a pop-up menu.
2. Highlight **Rectangular** and press **ENTER** to display the **RECTANGULAR POCKET** Graphic Menu. Refer to **Figure 4-16**.

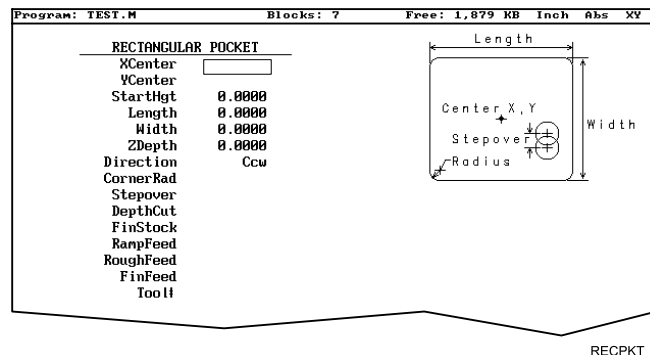

**Figure 4-16, RECTANGULAR POCKET Graphic Menu**

3. Fill in the **RECTANGULAR POCKET** entry fields:

**XCenter** X coordinate of the center. If you do not type a coordinate, the pocket centers at the present position. Optional.

**YCenter** Y coordinate of the center. If you do not type a coordinate, the pocket centers at the present position. Optional.

**StartHgt** Absolute Z position to which the CNC rapids to before feeding into the work. Value required.

**NOTE:** **StartHgt** is 0.100 inches (2.0 mm) above the work surface. **ZDepth** must be lower than **StartHgt**.

**Length** Inside Y length of the finished pocket. Value required.

**Width** Inside X length of the finished pocket. Value required.

**ZDepth** Absolute depth of the finished pocket. Value required.

**Direction** Allows you to select a clockwise (**Cw**) or counterclockwise (**Ccw**) direction. Press +/- to toggle the selection. Selection required.

**Stepover** Width of cut. If you do not type a value, the CNC defaults to 70% of the active tool radius. The maximum step-over permitted is 70% of the active tool diameter. Optional.

**DepthCut** Depth the machine takes in a single pass. Defaults to a single **ZDepth** cut minus the finish stock. Optional.

**FinStock** Amount of stock left by the machine before the finish pass. Default: 0. Type a negative value to leave the stock without making a finish pass. Optional.

**ZFeed** Z-axis feedrate. Optional.

**RoughFeed** Rough pass feedrate. Optional.

**FinFeed** Finish pass feedrate. Optional.

### Circular Pocket Cycle

Circular Pocket cycles simplify the programming of circular pockets. When executed, the CNC rapids to the center, rapids to the **StartHgt**, and then ramps into the work. The tool will circle outward from the center starting position, until it reaches the pocket **Diameter**. The tool circles back toward the center until the pass is complete.

The Circular Pocket Cycle automatically compensates for tool diameter. Activate the correct tool diameter before the **CircPock** block.

Use **DepthCut** to specify the number of passes required to get from the **StartHgt** to the **ZDepth**, cutting the **DepthCut** on each pass.

Use **FinStock** to leave the specified stock on the profile and depth for a finish pass. The cycle cuts the profile to the **Diameter** and **ZDepth** dimensions on the finish pass. Type a negative **FinStock** to leave the finish stock without making a finish pass.

Leave **RoughFeed** and **FinFeed** blank to execute feed moves at the current feedrate. **RoughFeed** controls the feedrate of the roughing cycle. **FinFeed** controls the feedrate of the finishing cycle.

To program a Circular Pocket cycle:

1. In Edit Mode, press **Pocket (F4)** to display a pop-up menu.
2. Move the highlight to select **Circular** and press **ENTER** to display the **CIRCULAR POCKET** Graphic Menu. Refer to **Figure 4-17**.

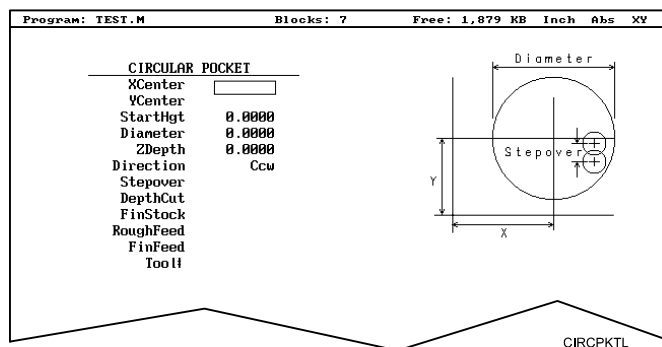

**Figure 4-17, CIRCULAR POCKET Graphic Menu**

3. Fill in the **CIRCULAR POCKET** entry fields:

- XCenter** X coordinate of the center. Default: present position. Optional.
- YCenter** Y coordinate of the center. Default: present position. Optional.
- StartHgt** Absolute Z position to which the CNC rapids before feeding into the work. Value required.

**NOTE:** **StartHgt** is 0.100 inches (2.0 mm) above the work surface. **ZDepth** must be lower than **StartHgt**.



<b>ZDepth</b>	Absolute depth of the finished hole. Value required.
<b>Direction</b>	Allows you to select a clockwise ( <b>Cw</b> ) or counterclockwise ( <b>Ccw</b> ) direction. Press +/- to toggle the selection. Selection required.
<b>Stepover</b>	Width of cut. If no value is typed, CNC defaults to 70% of the active tool radius. Maximum step-over permitted is 70% of the active tool diameter. Optional.
<b>DepthCut</b>	Depth the machine takes in a single pass. Defaults to a single <b>ZDepth</b> cut minus the finish stock. Optional.
<b>FinStock</b>	Amount of stock left by the machine before the finish pass. Default: 0. Type a negative value to leave the stock without making a finish pass. Optional.
<b>RoughFeed</b>	Rough pass feedrate. Optional.
<b>FinFeed</b>	Finish pass feedrate. Optional.

### Frame Pocket Cycle

A Frame Pocket Cycle simplifies the programming required to mill out a Frame. When executed, the CNC rapids to a starting position near the island, rapids to **StartHgt**, then ramps into the work while moving across the **Frame**. The CNC cuts from the outside edge to the island in rectangles of decreasing size to complete the pass.

The Frame Pocket Cycle automatically compensates for tool diameter. Activate the correct tool diameter before the **FramePock** block.

If you type a **DepthCut** value, the CNC executes the number of passes required to get from the **StartHgt** to the **ZDepth**, cutting the **DepthCut** on each pass.

Use **FinStock** to leave the specified stock on the profile and depth for a finish pass. The CNC cuts the frame to the **IslandLen**, **IslandWid**, and **FrameWidth** dimensions on the finish pass. Type a negative **FinStock** value to leave the finish stock without adding a finish pass.

Leave **RoughFeed** and **FinFeed** blank to execute feed moves at the current feedrate. **RoughFeed** controls the feedrate of the roughing cycle. **FinFeed** controls the feedrate of the finishing cycle.

To program a Frame Pocket cycle:

1. In Edit Mode, press **Pocket (F4)** to display a pop-up menu.
2. Highlight **Frame** and press **ENTER** to display the **FRAME POCKET** Graphic Menu. Refer to **Figure 4-18**.

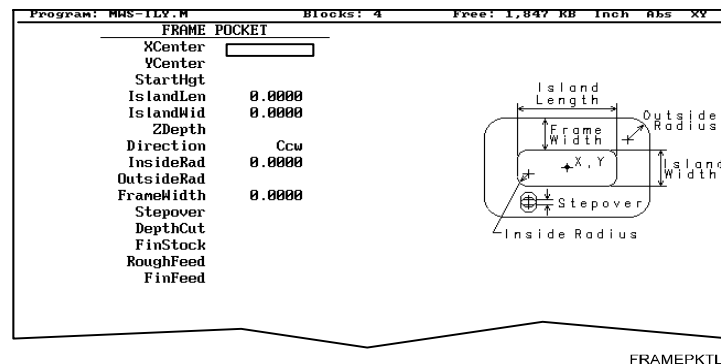

**Figure 4-18, FRAME POCKET Graphic Menu**

3. Fill in the **FRAME POCKET** entry fields:

- XCenter** X coordinate of the center. Default: pocket centers at present position. Optional.
- YCenter** Y coordinate of the center. Default: pocket centers at present position. Optional.
- StartHgt** Absolute Z position to which the CNC rapids before feeding into the work. Value required.

**NOTE:** **StartHgt** is 0.100 inches (2.0 mm) above the work surface. **ZDepth** must be lower than **StartHgt**.

<b>IslandLen</b>	Outside length (X-axis) of finished island. Value required.
<b>IslandWid</b>	Outside width (Y-axis) of finished island. Value required.
<b>StartHgt</b>	Absolute Z position to which the CNC rapids before feeding into the work. Value required.
<b>Direction</b>	Allows you to select conventional or climb milling for the pocket. The selections are clockwise ( <b>Cw</b> ) and counterclockwise ( <b>Ccw</b> ). Press +/- to toggle the selection. Selection required.
<b>InsideRad</b>	Radius of the island corners. Value required.
<b>OutsideRad</b>	Outside radius of the frame corners. Value required.
<b>FrameWidth</b>	Width of the finished frame. Value required.
<b>Stepover</b>	Width of cut. If no value is typed, the CNC defaults to 70% of the active tool radius. Maximum step-over permitted is 70% of the active tool diameter. Optional.
<b>DepthCut</b>	Z-axis increment used for each pass. Optional.
<b>FinStock</b>	Amount of stock left by the machine before the finish pass. Default: 0. Type a negative value to leave the stock without making a finish pass. Optional.
<b>RampFeed</b>	Z-axis feedrate. Optional.
<b>RoughFeed</b>	Rough pass feedrate. Optional.
<b>FinFeed</b>	Finish pass feedrate. Optional.

### Hole - Mill Cycle

Use Hole Mill cycles to cut through holes, clean up the inside diameter of existing holes, or counter-bore existing holes. When executed the CNC rapids to the ramp, feeds into the circumference along the ramp, and cuts to the **Diameter**. After it completes the hole, the CNC ramps away from the circumference and rapids back to the center.

The Hole Mill Pocket Cycle automatically compensates tool diameter. Activate the correct tool diameter before the **HolePock** block.

Use **StartHgt** and **ZDepth** together, if at all. Type a **DepthCut** to execute the number of passes required to get from the **StartHgt** to the **ZDepth**, cutting the **DepthCut** amount on each pass.

Use **FinStock** to leave the specified amount on the profile and make an additional pass cutting to the **Diameter**. Type a negative **FinStock** value to leave finish stock, without executing a finish pass.

Leave **RoughFeed** and **FinFeed** blank to execute feed moves at the current feedrate. **RoughFeed** controls the feedrate of the roughing cycle. **FinFeed** controls the feedrate of the finishing cycle.

To program a Hole Mill Pocket cycle:

1. In Edit Mode, press **Pocket (F4)** to display a pop-up menu.
2. Highlight **Hole** and press **ENTER** to display the **HOLE-MILL POCKET** Graphic Menu. Refer to **Figure 4-19**.

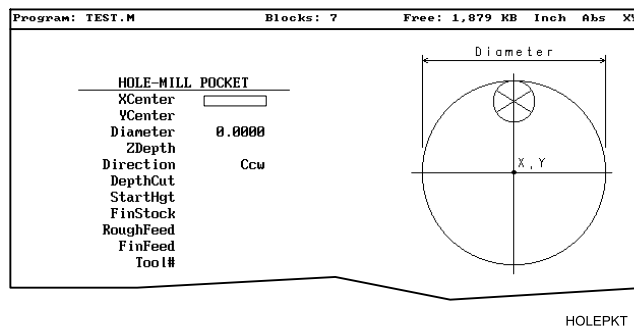

**Figure 4-19, HOLE-MILL Pocket Graphic Menu**

3. Fill in the **HOLE-MILL POCKET** entry fields:

- XCenter** X coordinate of the center. Default: pocket centers at present position. Optional.
- YCenter** Y coordinate of the center. If no coordinate is given, it defaults to present position. Optional.
- Diameter** Diameter of the pocket. Value required.
- ZDepth** Absolute depth of the finished pocket. Optional.

**NOTE:** Use **StartHgt** and **ZDepth** together, if at all. **ZDepth** must be lower than **StartHgt**.

<b>Direction</b>	Allows you to select a clockwise (Cw) or counterclockwise (Ccw) direction. Press +/- to toggle the selection. Selection required.
<b>DepthCut</b>	Z-axis increment used for each pass. Optional.
<b>StartHgt</b>	Absolute Z position to which the CNC rapids before feeding into the work. Optional.
<b>FinStock</b>	Amount of stock left by the machine before the finish pass. Default: 0. Type negative value to leave a finish stock, without making a finish pass. Optional.
<b>RoughFeed</b>	Rough pass feedrate. Optional.
<b>FinFeed</b>	Finish pass feedrate. Optional.

### Irregular Pocket Cycle

An irregular pocket cycle simplifies the programming of an irregular pocket. An **IRRegular** pocket block must contain a subprogram. The main portion of the block holds the information required to mill the pocket. The moves in the subprogram define the pocket's profile.

Begin the subprogram with a Rapid move to an absolute starting position on the profile. Following blocks provide the moves that define the outline. After the profile is completed, return to the starting position.

**NOTE:** To test the subprogram that defines the outline, program a temporary subprogram call in the beginning of the main program and run the program in Simulation Draw Mode. Delete or comment out the subprogram call before actually running the program. Refer to "[Subprograms](#)" in this section for information on how to program a subprogram. Refer to "[Section 5 - Editing Programs](#)" for information on how to comment out a block.

The cycle mills out the pocket interior in progressive side-to-side moves that step over across the pocket. The machine reverses direction when it reaches any part of the pocket outline. You must orient the stepovers, starting point, and direction so that an irregularity in the outline does not prevent the entire pocket from being milled. Refer to **Figure 4-20**.

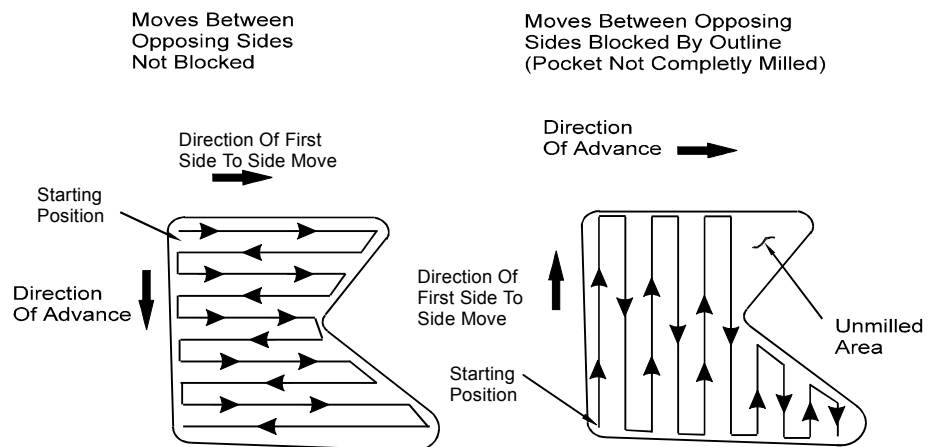

**Figure 4-20, Stepover Move Orientation**

### Determining Move Direction

Two factors determine how moves step over across the pocket:

- The starting position of the first move.
- The direction of the first move.

The CNC uses the moves in the subprogram to generate the default starting position and the direction of the first move. Refer to **Figure 4-21**.

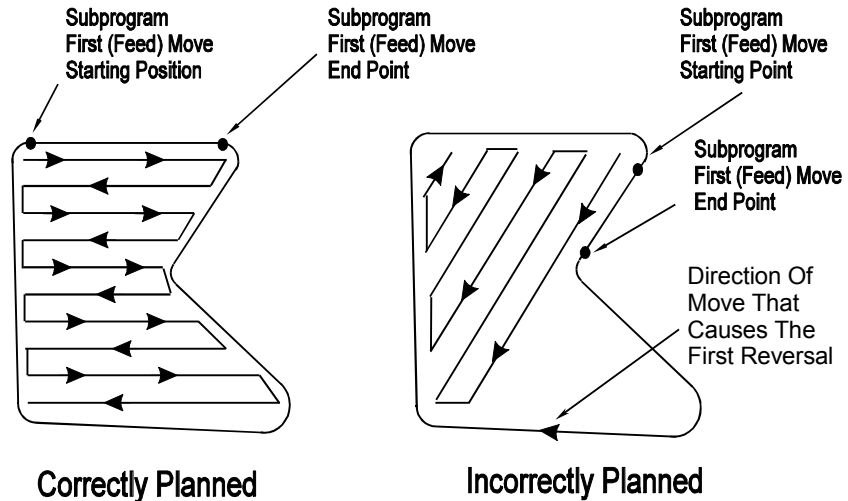

**Figure 4-21, Orienting Stepmover from the Subprogram**

You should set the default starting position at the intersection of the first and last moves in the subprogram (compensated for tool diameter and **Finstock**). If this was done, do not type values in the **Angle**, **X**, and **Y** fields. The default direction will be parallel to the first Line move in the subprogram.

When the **Angle**, **X**, and **Y** fields are left blank and the first move of the subprogram is an Arc, the CNC sets the default starting position at the intersection of the Arc and the last feed move in the subprogram (compensated for tool diameter and **Finstock**). The default starting direction will be parallel to a tangent drawn through the Arc's endpoint.

The CNC will step over perpendicular to the first move, following the outline of the subprogram's moves.

**NOTE:** Use a Line move for the first move in the subprogram whenever possible.

For most irregular pockets, leave the **Angle**, **Xstart**, and **YStart** fields blank.

Type an **Angle** to force the direction of the first move to the typed absolute angle. The angle must point to a direction inside the pocket in order for the cycle to run. Refer to **Figure 4-22**.

**NOTE:** When an Arc in the subprogram defines the start position of the cycle and you specify an **Angle** value, ensure that the angle points inside the pocket. An angle tangent to the starting point of an Arc does not point to the inside of the Arc. If necessary, adjust the angle so that it points toward the inside of the pocket ( $\pm 1.00$  degrees).

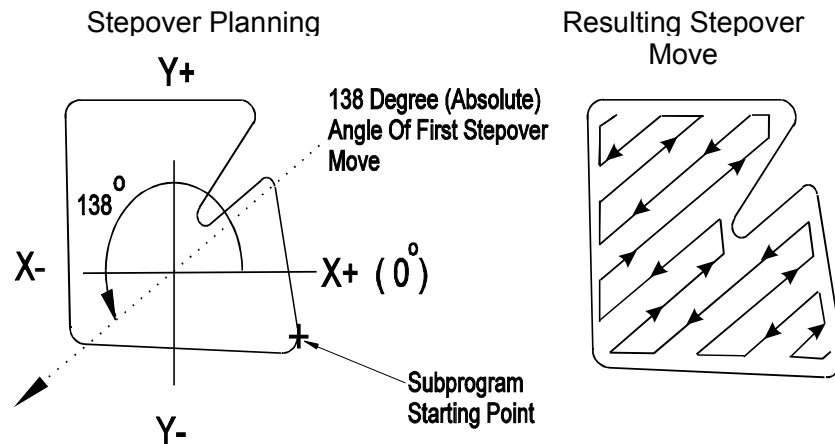

**Figure 4-22, Specifying Move Angle**

Type **X** and **Y** values to force the starting position of the first move to the specified position, compensating for tool diameter and **FinStock**.

**IRRegular Pocket Execution**

When executed, the CNC rapids to the starting position, rapids to **StartHgt**, then moves to the Z depth of the first pass.

The Irregular Profile Cycle automatically compensates for tool diameter. Activate the correct tool diameter before the **Pocket** block.

Use **XStart** and **YStart** to start the cycle with a ramping move from the **XStart**, **YStart** position to the step-over starting position.

The CNC mills out the pocket with side-to-side moves that step over across the pocket.

Use **DepthCut** to specify the number of passes required to get from the top of the part to **ZDepth**, cutting to the **DepthCut** on each pass.

Use **FinStock** to leave specified stock on the profile and depth for a finish pass. The CNC cuts the pocket to final dimensions on the finish pass. Type a negative **FinStock** value to leave the finish stock without making a finish pass.



When you do not type a **RoughFeed** or **FinFeed** value, the CNC executes feed moves at the current feedrate. **RoughFeed** controls the feedrate of the roughing cycle. **FinFeed** controls the feedrate of the finishing cycle.

To program an Irregular Pocket cycle:

1. In Edit Mode, press **Pocket (F4)** to display a pop-up menu.
2. Highlight **IRRegular** and press **ENTER** to display the **IRREGULAR POCKET** Graphic Menu. Refer to **Figure 4-23**.

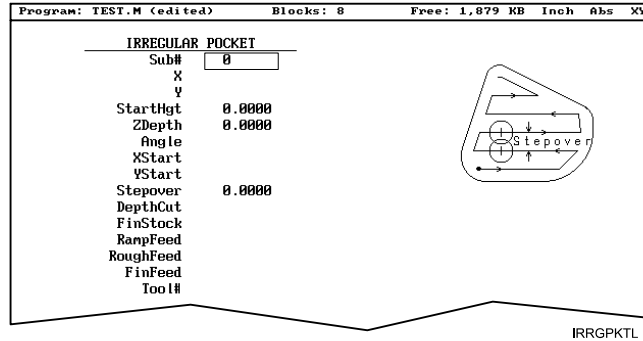

**Figure 4-23, IRREGULAR POCKET Graphic Menu**

3. Fill in the **IRREGULAR POCKET** entry fields:

<b>Sub#</b>	Subroutine that defines shape of the pocket. Value required.
<b>X</b>	X coordinate of the step-over starting position. If no value is typed, the CNC defaults to the starting position of the first move of the subprogram. Optional.
<b>Y</b>	Y coordinate of the step-over starting position. If no value is typed, the CNC defaults to the starting position of the first move of the subprogram. Optional.

**NOTE:** Use **X** and **Y** values together, if at all.

<b>StartHgt</b>	Absolute Z position to which the CNC rapids before feeding into work. Value required.
-----------------	---

**NOTE:** **StartHgt** is 0.100 inches (2.0 mm) above the work surface to be cut. **ZDepth** must be lower than **StartHgt**.

<b>ZDepth</b>	Absolute depth of the finished pocket. Required.
<b>Angle</b>	Absolute angle of the first move. If blank, the first move of the step-over is parallel to the first line move of the subprogram. Optional.
<b>XStart</b>	X coordinate of the ramp move to the starting position. Optional.

**YStart** Y coordinate of a ramp move to the starting position. Optional.

**NOTE:** Use **XStart** and **YStart** values together, if at all.

**Stepover** Width of cut. Value required.

**DepthCut** Z-axis increment used for each pass. Optional.

**FinStock** Amount of stock left by the machine before the finish pass. Default: 0. Use a negative value to leave stock without making a finish pass. Optional.

**RampFeed** Z-axis feedrate. Optional.

**RoughFeed** Rough pass feedrate. Optional.

**FinFeed** Finish pass feedrate. Optional.

### Using Irregular Pocket in Subprograms

The Irregular Pocket is typically used with the main program. In cases where the Irregular Pocket is being used in a subprogram, an M-code must be used to specify the tool number whose tool diameter must be used in the calculations of the Irregular Pocket. The M-code must be placed immediately before the Irregular Pocket. If Irregular Pocket is used in the main program, it is not necessary to use this M-code.

**Format:** MCode 9367 X (tool#)

Tool# is the number of the tool diameter whose diameter must be used in the calculations of the Irregular Pocket.

**Example:**

```
MCode 9367 X 3.0000
Pocket      Sub# 1 StartHgt 0.1000 (etc.)
```

This will use the diameter of Tool# 3 in the calculations of the Irregular Pocket.

## Pockets with Islands

This cycle allows islands in irregular pockets. The main pocket must be the lowest subroutine number. Normally, this would be one (1). Pockets with Islands can be programmed using:

- DXF
- Subroutines

More than one Island cycle can be programmed at a time. They may be strung together, but on separate lines. Islands can be programmed inside of islands. Five islands can be put on a line. The shape number subroutine number is used as inputs.

## Using DXF for Pockets with Islands

In DXF, make outside profile shape #1 or lowest number. Then all islands thereafter, the order is not important. When saving these, use Cam Shape. Refer to **Figure 4-24**.

1. Highlight the DXF filename, and press **Utility (F9)**.
2. Highlight **DXF Converter**, and press **ENTER**.
3. Press **SETUP**, select **OUTPUT format**, press **ENTER**.
4. Select **CAM Shape**, and press **ENTER**. Refer to **Figure 14-24**.
5. Select to **Convert values**, and press **ENTER**.
6. Select **Metric**, and press **ENTER**.
7. Press **Exit** twice.

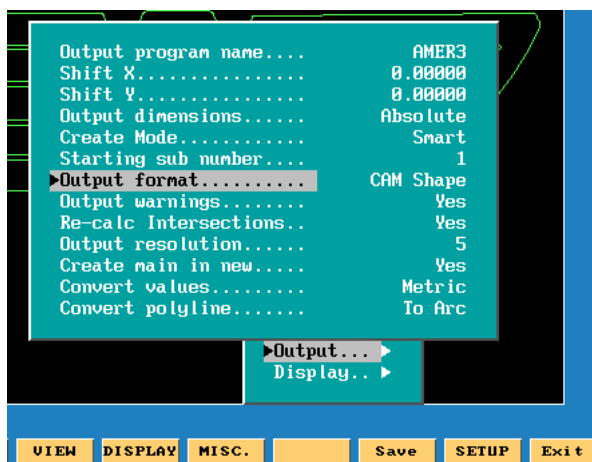

**Figure 4-24, DXF Output format, CAN Shape Pop-up Menu Illustration**

Using **Figure 4-25** as an example:

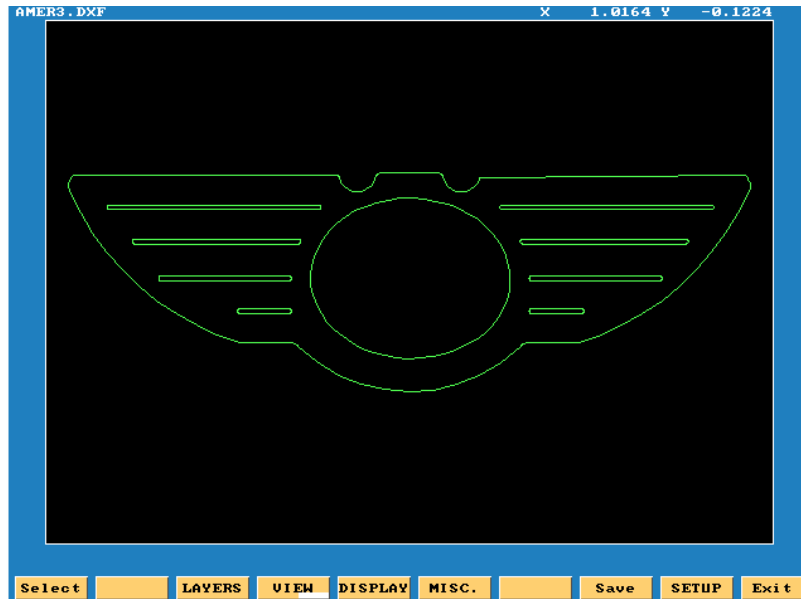

**Figure 4-25, DXF Pockets with Islands Example Workpiece**

1. Select a start point on outer profile and make shape #1. A good point on the workpiece illustrated is just below the radius top left.
2. Select next shape, until all 10 shapes are selected.
3. Press **Save (F9)**, it will save all 10 CAM shapes.
4. Press **Exit (F10)**.
5. Press **Yes (F1)** to exit.

An AMER3.G program needs to be created. Then the AMER3.G program is created, a pop-up list of programs is displayed. See **Figure 4-26**.

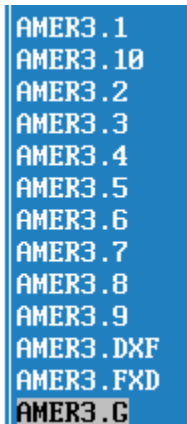
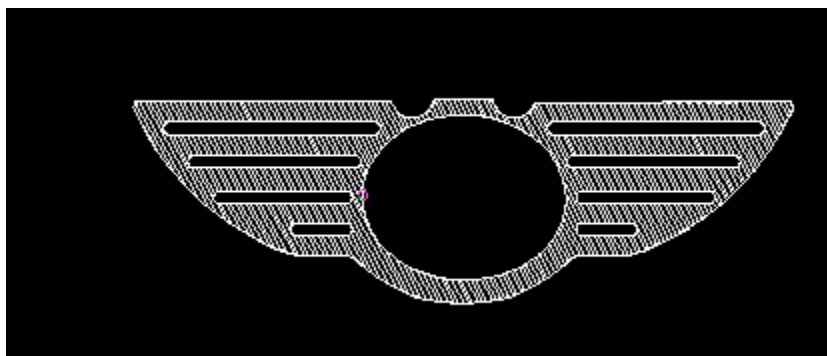

**Figure 4-26, DXF Program Listing Pop-up Menu Illustration**

**DXF Program Example****Table 4-1, DXF Pockets with Islands Programming Example**

1.	Dims Abs
2.	Offset Fixture# 1
3.	Tool #1
4.	Islands First Isl 1 Second Isl 2 Third Isl 3 Fourth Isl 4 Fifth Isl 5
5.	Islands First Isl 6 Second Isl 7 Third Isl 8 Fourth Isl 9 Fifth Isl 10
6.	Pocket Sub# 1 StartHgt 0.1000 Zdepth -0.0050 Angle 300.0000 Stepover .0100 Fin Stock 0.0010 RampFeed 30.0 Rough Feed 30.0 FinFeed 30.0
7.	RapidZ 2.0000
8.	Rapid X 0.0000 Y 0.0000
9.	EndMain

The completed DXF Pockets with Islands example is illustrated in **Figure 4-27**. The rapid moves are turned off in this illustration.

**Figure 4-27, DXF Pockets with Islands Completed Example Workpiece**

**Using Subroutines for Pockets with Islands**

This example using subroutines for Pockets with Islands uses the following illustration. See **Figure 4-28** and **Table 4-2**.

The numbers are the subroutine numbers.

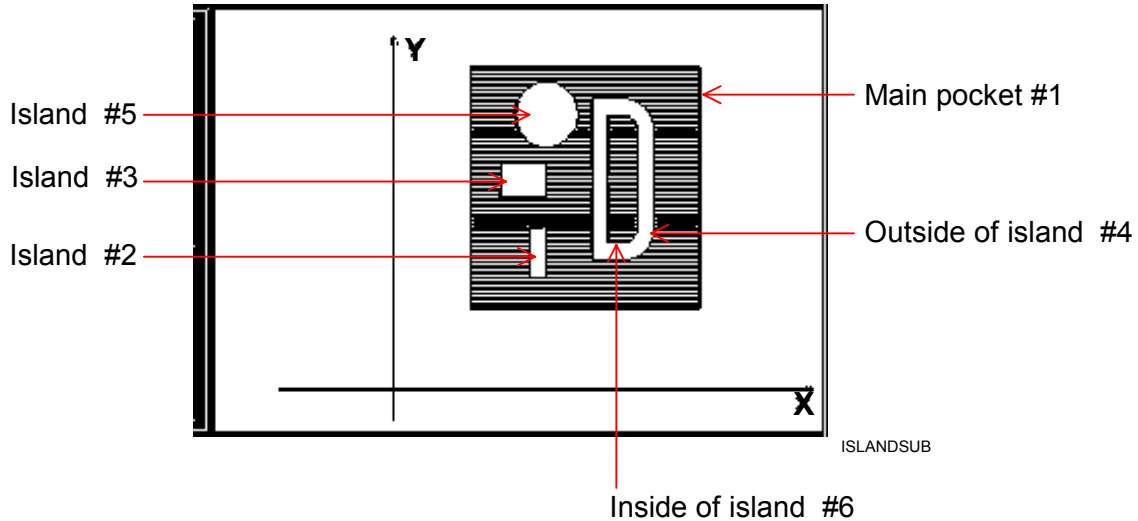

**Figure 4-28, Subroutines Pockets with Islands Example Workpiece**

In **Table 4-2** Island # 4 (FourthIsl) has a – (minus) in front of it, this is because the comp needs to be on the inside, as it is a pocket inside of an island.

**Table 4-2, Pockets with Islands Subroutines Programming Example**

```

Unit Inch
Dim Abs
Tool# 0
Rapid          X 0.0000 Y 0.0000 Z 0.0000 Feed 50.0000
Islands        FirstIsl 4.0000 SecondIsl 3.0000 ThirdIsl 2.0000
FourthIsl -6.0000 FifthIsl 5.0000
Pocket         Sub# 1.0000 StartHgt 0.2000 ZDepth -0.9000 Stepover
0.1900 DepthCut 0.2500 RoughFeed 50.0000 FinStock 0.0100
FinFeed 50.0000
RampFeed 50.0000 Tool# 1.0000
MCode 5 Z 5.0000
EndMain
Sub 1
Rapid          X 5.0000 Y 5.0000 Feed 50.0000
Line           X 20.0000
Line           Y 20.0000
Line           X 5.0000
Line           Y 5.0000
EndSub
    
```

```
Sub 2
Rapid      X 9.0000 Y 7.0000 Feed 50.0000
Line       X 10.0000
Line       Y 10.0000
Line       X 9.0000
Line       Y 7.0000
EndSub
Sub 3
Rapid      X 7.0000 Y 12.0000 Feed 50.0000
Line       X 10.0000
Line       Y 14.0000
Line       X 7.0000
Line       Y 12.0000
EndSub
Sub 4
Rapid      X 13.0000 Y 8.0000 Feed 50.0000
Line       X 15.0000
Arc Ccw    X 17.0000 Y 10.0000 Radius 2.0000
Line       Y 16.0000
Arc Ccw    X 15.0000 Y 18.0000 Radius 2.0000
Line       X 13.0000
Line       Y 8.0000
EndSub
Sub 5
Rapid      X 8.0000 Y 17.0000 Feed 50.0000
Arc Ccw    X 12.0000 Y 17.0000 Radius 2.0000
Arc Ccw    X 8.0000 Y 17.0000 Radius 2.0000
EndSub
Sub 6
Rapid      X 14.0000 Y 9.0000
Line       X 15.0000
Arc Ccw    X 16.0000 Y 10.0000 Radius 1.0000
Line       Y 16.0000
Arc Ccw    X 15.0000 Y 17.0000 Radius 1.0000
Line       X 14.0000
Line       Y 9.0000
EndSub
```

## Subprograms

Program repetitive operations in a subprogram called from the main program.

- ❑ Call (or nest) subprograms within other subprograms. The CNC supports up to ten levels of nesting.
- ❑ Repeat or loop subprograms moving along any axis in increments each time the loop runs. ,
- ❑ Rotate, scale, or mirror subprograms.

The following examples describe two situations where subprograms save time.

### Situation: 1 (Repetitive Drilling Cycle)

When a workpiece must be center-drilled, drilled, then counterbored, each of the three tools must go to the same hole positions consecutively. Ten hole positions would require thirty programmed hole locations (ten for each tool). Program the ten hole locations in a subprogram called three times from the main program (once for each tool).

### Situation: 2 (Rough and Finish Cycles)

Use subprograms for jobs that require both roughing and finishing cycles. Rough out the outside of a workpiece with a roughing mill, then finish it with a finishing mill. Program the profile in a subprogram. The main program calls the subprogram twice, once for each tool. You can set the tool diameter to 0.5300 inches for the .5-inch roughing mill and to 0.5000 inches for the .5-inch finishing mill. Tool #1 will leave 0.0150 inch excess stock per side. Tool #2 finishes the work to size.

### Subprogram Structure

When using subprograms, define the end of the main program and the start and end of each subprogram

### Subprogram Example

1	Dim Abs		
2	Rapid	X 5.0000	Y -5.0000
3	Call 1		
4	Rapid	X 6.0000	Y -6.0000
5	Call 1		
6	Rapid	X 7.0000	Y -5.0000
7	Call 1		
<b>8</b>	<b>EndMain</b>		
<b>9</b>	<b>Sub 1</b>		
10		Z -0.0625	
11	Dim Incr		
12	Line	X 0.375	
13	Line	Y 0.375	
14	Line	X -0.375	
15	Line	Y -0.375	

**End of Main Program**  
**Start of Subprogram 1**



```
16 Dim Abs
17           Z 0.1000
18 EndSub
19 <End Of Program>
```

**End of Subprogram 1**  
**End of Program**

The main program begins at Block 1 and runs through Block 8. The subprogram begins at Block 9 and runs through Block 18.

When the main program reaches Block 3, the CNC jumps to Block 9, runs the subprogram through Block 18, then returns to the main program, Block 4.

Blocks 5 and 7 call the subprogram again.

### Organizing Programs Containing Subprograms

To write a program that includes a subprogram:

1. Write the main program and include the subprogram **Call** blocks.
2. Insert an **EndMain** block at the end of the main
3. Insert a **Sub** block, followed by a unique subprogram call number (1 to 9999), on the first block of the subprogram. Example: Sub1.
4. Write the subprogram blocks.
5. Finish the subprogram with an **EndSub** block.
6. End the program with an **<End of Program>** block.

## Calling Subprograms from the Main Program

To call a subprogram from the main program:

1. In Edit Mode, press **Sub (F8)** to display the Subprogram soft key labels.
2. Press **Call (F3)**. The Graphic Menu prompts for the subprogram number.
3. Type a subprogram number and press **ENTER** to add **Call** block to program.

## Ending Main Programs

To program an **EndMain** block:

1. In Edit Mode, press **Sub (F8)** to display the Soft Key subprogram labels.
2. Press **EndMain (F4)** to display the **EndMain** block in the program listing.

## Starting Subprograms

Start subprograms with a **Sub** block.

To program a **Sub** block:

1. In Edit Mode, press **Sub (F8)** to display the **Sub** soft keys.
2. Press **Sub (F2)**. The CNC prompts for subprogram number.
3. Type **Sub** number and press **ENTER** to add a **Sub** block to the program. The **Sub** number must agree with the matching **Call** number.

## Ending Subprograms

End subprograms with an **EndSub** block.

To program an **EndSub** block:

1. In Edit Mode, press **Sub (F8)** to display the **Sub** soft keys.
2. Press **EndSub (F2)** to add an **EndSub** block to the program.

### Looping Subprograms

Looping subprograms repeat a set number of times before they return to the main program. The CNC tracks the number of loops.

**NOTE:** Only subprograms can loop.

To call a Loop subprogram:

1. In Edit Mode, press **Sub (F8)** to display the **Sub** soft keys.
2. Press **Loop (F5)** to activate the **LOOP SUB** Graphic Menu.
3. Fill in the **LOOP SUB** entry field:

<b>Sub#</b>	Subprogram identification number. Value required.
<b>#Loops</b>	Number of times loop repeats before it returns to the main program. Value required.
<b>Xincr</b>	Distance X-axis increments every cycle. Optional.
<b>Yincr</b>	Distance Y-axis increments every cycle. Optional.
<b>Zincr</b>	Distance Z-axis increments every cycle. Cannot be used with <b>Xincr</b> or <b>Yincr</b> . Optional.
<b>ZFeed</b>	Feedrate used with <b>Zincr</b> . Optional.
<b>Tool#</b>	Active tool. Optional.

### Rotating, Mirroring, and Scaling Subprograms (RMS)

Use **RMS** blocks to scale, rotate, and/or mirror subprograms. These functions turn off when the subprogram ends.

To call an RMS subprogram:

1. In Edit Mode, press **Sub (F8)**. Soft Key labels display subprogram functions.
2. Press **RMS (F6)**. The **ROTATE/MIRROR/SCALE SUB** Graphic Menu prompts for labeled values. Refer to **Figure 4-29**.

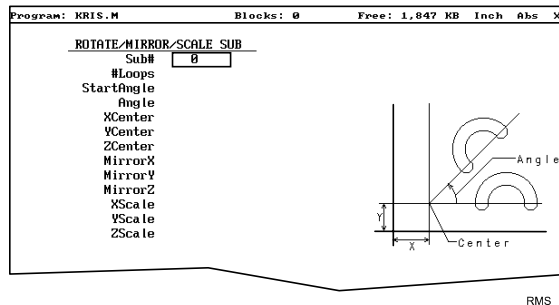

**Figure 4-29, ROTATE/MIRROR/SCALE SUB Graphic Menu**

3. Fill in the **ROTATE/MIRROR/SCALE SUB** entry fields defined below:

- Sub#** Subprogram number. Value required.
- 99#Loops** Number of times subprogram will loop before it returns to the main program. Optional.

**NOTE: RMS** subprograms loop only when rotating.

- StartAngle** Number of degrees the pattern rotates for the first loop. Optional.

**NOTE:** Sometimes, it is easier to program a part from the 3 o' clock position, then rotate it to desired angle.

- Angle** Number of degrees the pattern rotates per loop. Optional.
- XCenter** Point of rotation X coordinate. Optional.
- YCenter** Point of rotation Y coordinate. Optional.
- MirrorX** Press +/- to toggle between **Yes** and **No**. If **Yes**, CNC mirrors the X-axis values. Optional.
- MirrorY** Press +/- to toggle between **Yes** or **No**. If **Yes**, mirrors the Y-axis values. Optional.
- XScale** X-axis scale factor. Multiplies all X-axis positions by the number typed. Optional.
- YScale** Y-axis scale factor. Multiplies all Y-axis positions by the number typed. Optional.

### Ellipses and Spirals

**NOTE:** It is possible for you to inadvertently write a block containing illogical entries. For safety, the CNC stops a program and generates a message when it detects an illogical block. Test programs in Draw to detect these blocks before machining a part.

#### Plane Selection

XY is the default plane for Ellipses and Spirals. For an XZ or YZ Ellipse or Spiral, program the plane change before the move.

The plane block allows the CNC to configure the Ellipse and Spiral Graphic Menus for the new plane.

The Graphic Menus for moves in the XY, XZ, and YZ planes contain the same entry fields. Entry fields for in-plane positions always require a value. Entry fields for off-plane positions do not.

After programming moves in other planes, always return to the XY plane.

### Programming an Ellipse

The Ellipse Cycle simplifies the programming required to cut an ellipse. When the Ellipse Cycle runs, the CNC feeds from its current location, around the ellipse, to the endpoint. The start point and the endpoint must lie along the ellipse. Use incremental values to program an ellipse. The cutter must be in place before the ellipse is executed.

Standard tool compensation cannot be used with the Ellipse Cycle. Use the **CompSide** entry to activate tool compensation on an ellipse.

- In** The CNC offsets the programmed path by the tool radius to the inside of the ellipse.
- Out** The CNC offsets the programmed path by the tool radius to the outside of the ellipse.
- None** (leave entry field blank). No compensation is activated during the cycle.

Press the +/- key to toggle the selection.

**NOTE:** To clear the entry field, press **CLEAR**.

To program an Ellipse:

1. In Edit Mode, press **Mill (F5)** to display the Mill soft key labels.
2. Press **More (F7)** to display the **More** pop-up menu.
3. Highlight **Ellipse** and press **ENTER** to display the **ELLIPSE** Graphic Menu. Refer to **Figure 4-30**.

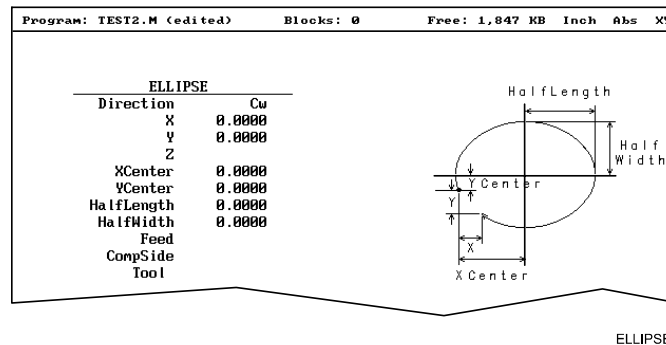
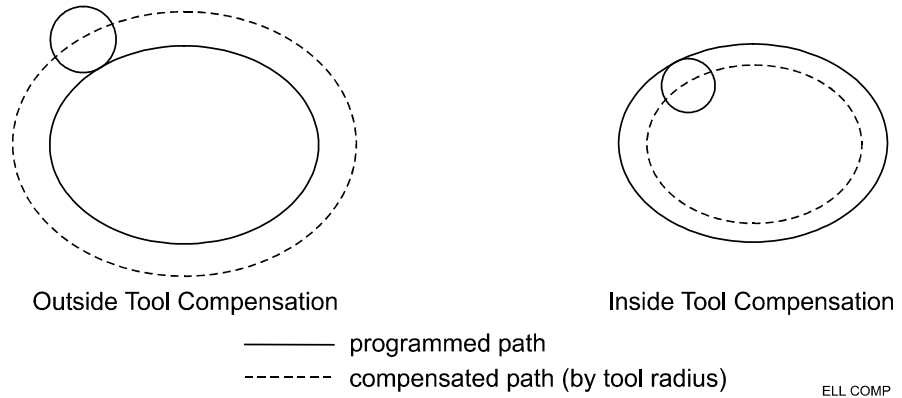

**Figure 4-30, ELLIPSE Graphic Menu**

4. Fill in the **ELLIPSE** entry fields:

- Direction** Allows you to select a clockwise (**Cw**) or counterclockwise (**Ccw**) direction. Press +/- to toggle the selection. Selection required.
- X** Incremental X coordinate of endpoint. Value required.
- Y** Incremental Y coordinate of endpoint. Value required.
- Z** Incremental Z coordinate of endpoint. Value required.
- XCenter** X coordinate of ellipse centerline. Value required.

<b>YCenter</b>	Y coordinate of ellipse centerline. Value required.
<b>HalfLength</b>	Half the overall X dimension of the ellipse. Incremental value required.
<b>HalfWidth</b>	Half the overall Y dimension of the ellipse. Incremental value required.
<b>Feed</b>	Feedrate. Optional.
<b>CompSide</b>	Offsets tool path to the inside ( <b>In</b> ) or outside ( <b>Out</b> ) of the ellipse by the tool radius. Refer to <b>Figure 4-31</b> . If you leave the entry blank, no tool compensation is activated during the cycle. Optional.



**Figure 4-31, Ellipse Tool Compensation**

### Programming a Spiral

A spiral is an arc with a continuously changing radius. To program a spiral, type the **Direction** of the cut, the **X** and **Y** coordinates of the endpoint, the coordinates of the center (**XCenter**, **YCenter**) and the number of revolutions (**Revs**). Program a spiral using incremental values.

When the cycle runs, the CNC cuts from its present position to the endpoint, spiraling around the center for the required number of revolutions. Each time the tool spirals past the starting point, it counts as one revolution. The machine automatically calculates and executes the required number of revolutions. There are two ways to set up spirals:

**Outward spirals** the present position is closer to the center than to the endpoint.

**Inward spirals** the endpoint is closer to the center than to the machine's current position.

To program a Spiral cycle:

1. In Edit Mode, press **Mill (F5)** to display the Mill soft key labels.
2. Press **More (F7)** to display the **More** pop-up menu.
3. Highlight **Spiral** and press **ENTER**. The **SPIRAL** Graphic Menu prompts for labeled values. Refer to **Figure 4-32**.

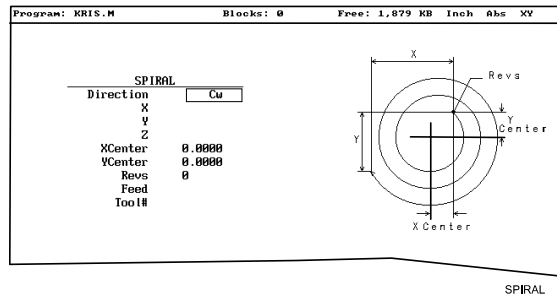

**Figure 4-32, SPIRAL Graphic Menu**

4. Type the required values and settings in the entry fields:

<b>Direction</b>	Allows you to select a clockwise ( <b>Cw</b> ) or counterclockwise ( <b>Ccw</b> ) direction. Press +/- to toggle the selection. Selection required.
<b>X</b>	Incremental X coordinate of endpoint. Optional.
<b>Y</b>	Incremental Y coordinate of endpoint. Optional.
<b>Z</b>	Incremental Z coordinate of endpoint. Optional.
<b>XCenter</b>	Incremental X coordinate of center. Value required.
<b>YCenter</b>	Incremental Y coordinate of center. Value required.
<b>Revs</b>	Number of complete revolutions made in the cycle. Value required.
<b>Feed</b>	Feedrate. Optional.

## Mold Cycles

### Programming a Mold Rotation

Use a Mold Rotation to mill cylindrically symmetrical cavities and cores. To define cylindrically symmetrical shapes, rotate a profile around an axis. Refer to **Figure 4-33**.

There are two categories of mold rotation:

- Rotation around X- or Y-axes
- Rotation around the Z-axis

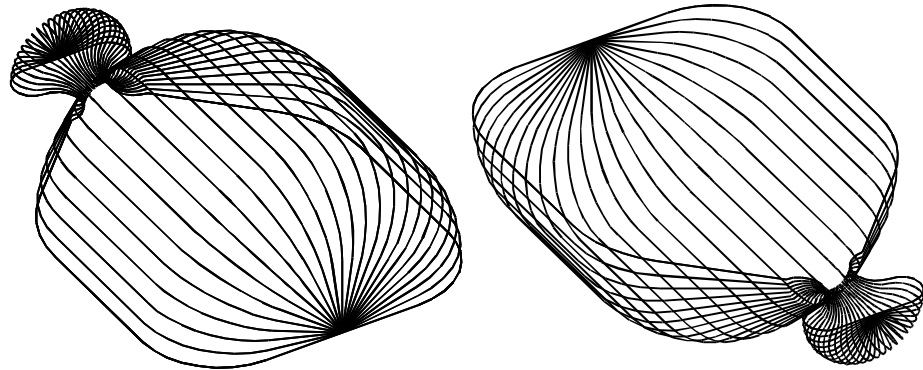
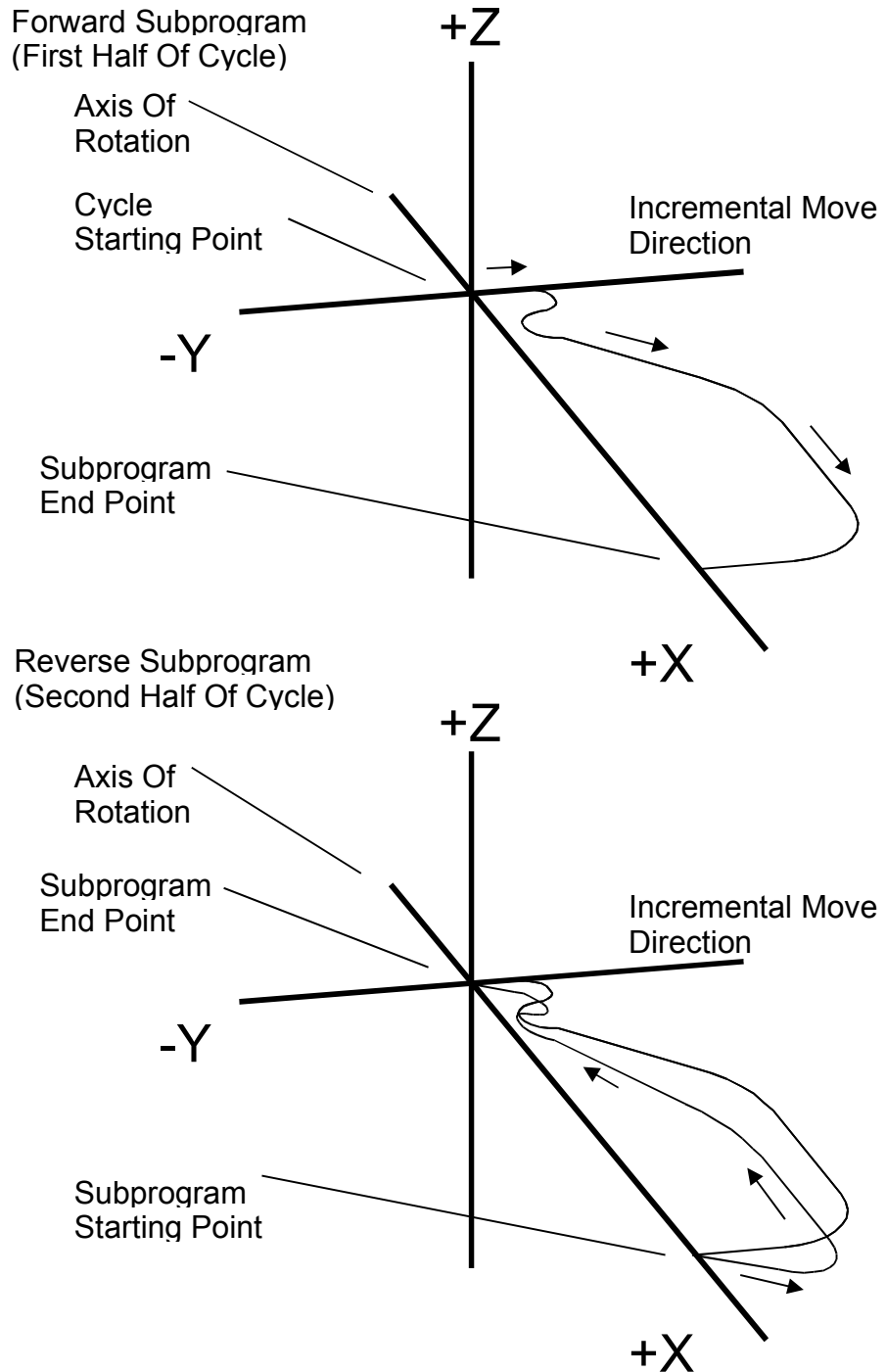

**Figure 4-33, XY Symmetrical Axis Mold Rotations**



### Rotations Around X and Y Axes (Small Radius)

Each Mold Rotation block requires two subprograms: a forward subprogram (**FwdSub**) to define the profile moving away from the starting point and a reverse subprogram (**RevSub**) to define the profile moving back to the starting point. Refer to **Figure 4-34**.

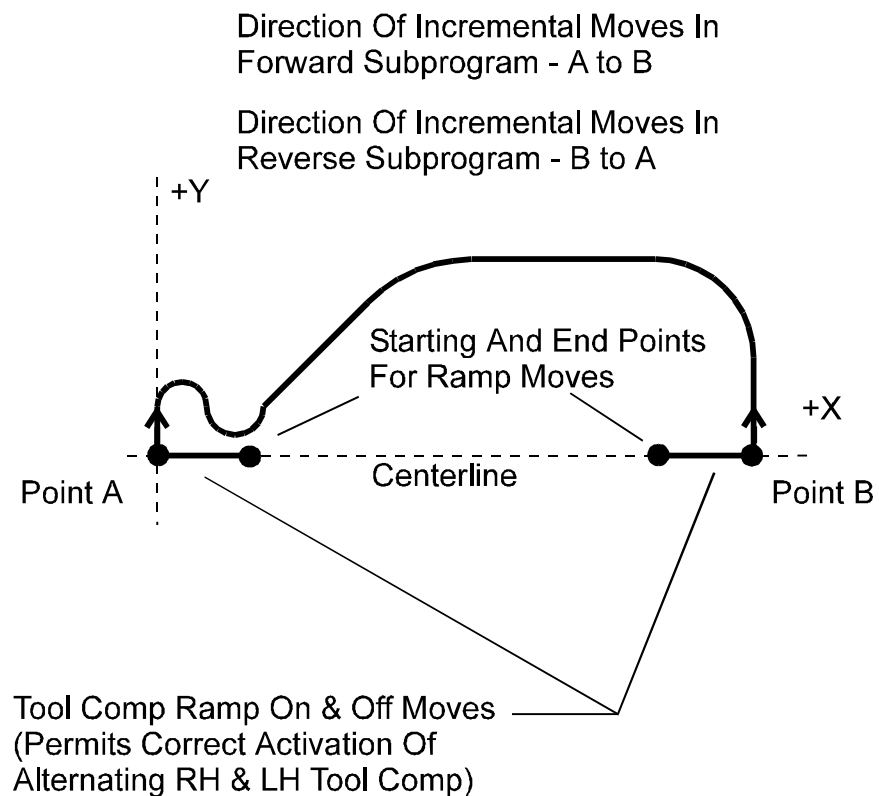

**Figure 4-34, Subprogram Orientation**

The CNC first executes the forward subprogram to the profile endpoint. It then executes the reverse subprogram back to the starting point. The CNC increments each cycle around the axis of rotation, from the **StartAngle** to the **EndAngle**. The number of **Cycles** and the size of the start and end angle values programmed into the block determine the amount of rotation for each increment.

The cycle starts to cut the first subprogram (profile) from the machine's current position.

In small radius rotations, subprogram start and endpoints can lie along the centerline of rotation. Make all subprogram moves incremental. The two subprograms (forward and reverse) must produce the same profile, but run in opposite directions. Refer to **Figure 4-35**.



MOLDSUB1

**Figure 4-35, Subprogram Specifics**

For rotation around the X-axis, include all subprogram moves in the +Y half of the XY plane. For rotation around the Y-axis, include all subprogram moves in the +X half of the XY plane.

When tool compensation is not used, adjust the path in the subprogram for the radius of the tool. If cutting a core, increase the path by one tool radius. If cutting a cavity, reduce the path by one tool radius.

Write compensated moves to the subprogram. Remember that tool compensation (left of path and right of path) will reverse in the two subprograms.

Program ramp moves in subprograms. Every time tool compensation activates, the CNC executes the programmed ramp on/off move for position adjustment.

The rotation occurs around the axis selected in the **AxisRot** field (centerline of rotation). Use **CAxisCL** and **BAxisCL** values to define the position of a centerline not located on the axis zero (X0, Y0, Z0). Refer to **Figure 4-36**.

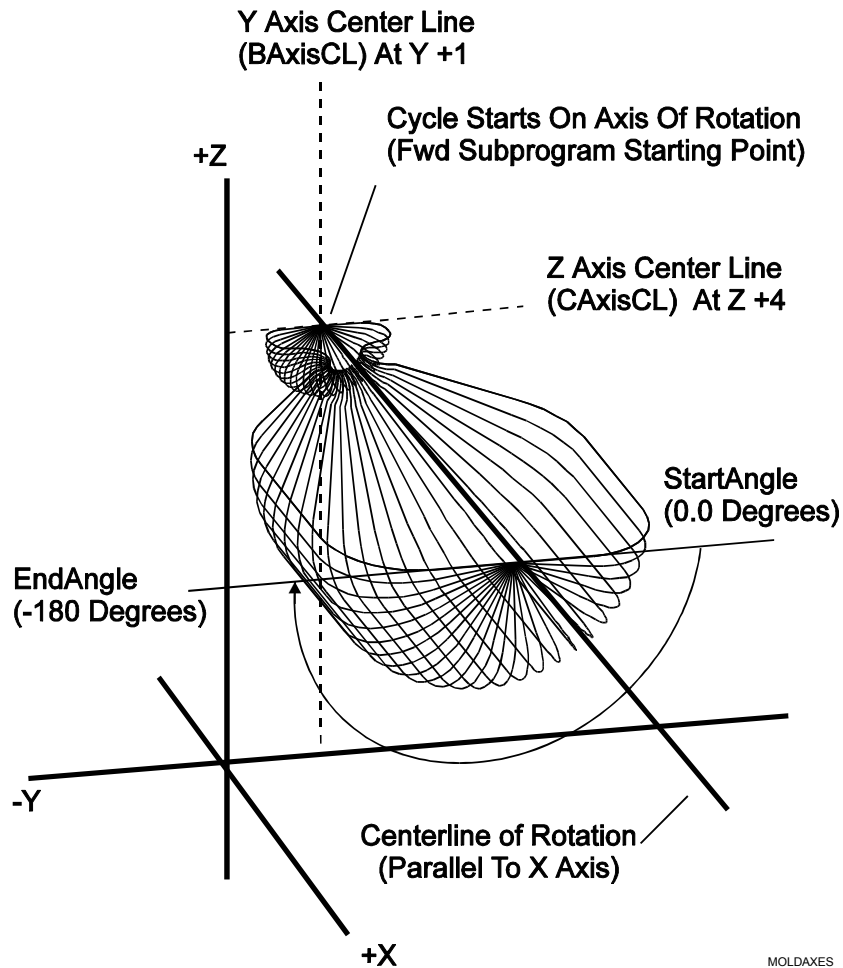

**Figure 4-36, Axes of Rotation**

When the shape rotates around the X-axis, the Y-axis position (in the **BAxisCL** field) and the Z-axis position (in the **CAxisCL** field) define the centerline.

When the shape rotates around the Y-axis, the X-axis position (in the **BAxisCL** field) and the Z-axis position (in the **CAxisCL** field) define the centerline.

The **StartAngle** and **EndAngle** are absolute angles that define the rotation. To program a cavity or core, first determine the orientation (positive or negative) of each angle in the subprogram.

To execute a Mold Rotation that requires more than one pass, write the subprograms for the finished shape and call the subprograms from more than one Mold Rotation block.

Vary the starting position and **CAxisCL** value of each block to bring each pass closer to the finished shape. To cut a core, reverse the sequence shown in the figure. Refer to **Figure 4-37**.

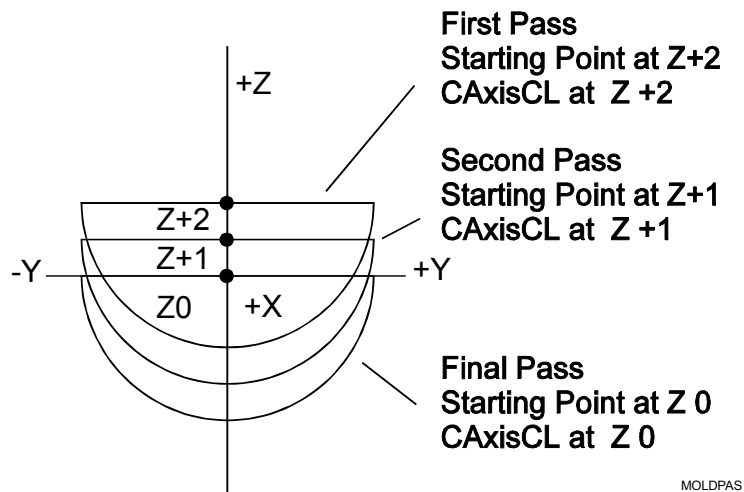

**Figure 4-37, Cutting a Cavity Using More than One Pass**

To rotate the XY shape around the Z-axis, type a **ZAngle**. Refer to **Figure 4-38**.

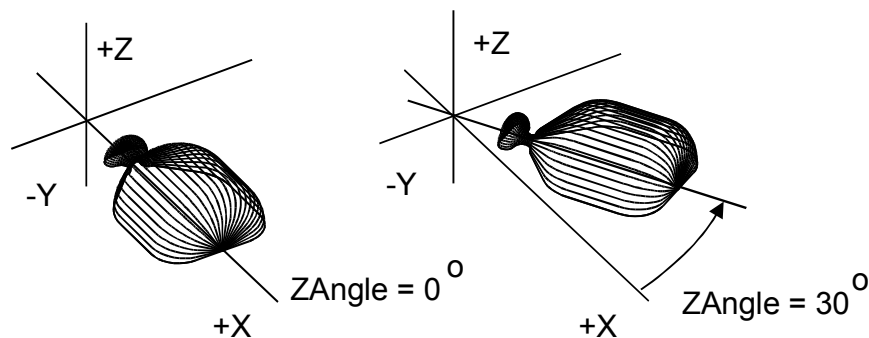

**Figure 4-38, Rotating XY Mold Rotations Around Z**

### Rotations Around X and Y Axes (Large Radius)

The mold rotation cycle executes subprograms starting at the present position. To cut a large radius rotation, start the cycle at the required distance from the centerline. The CNC automatically adds the distance to the radius of the rotation. Refer to **Figure 4-39**.

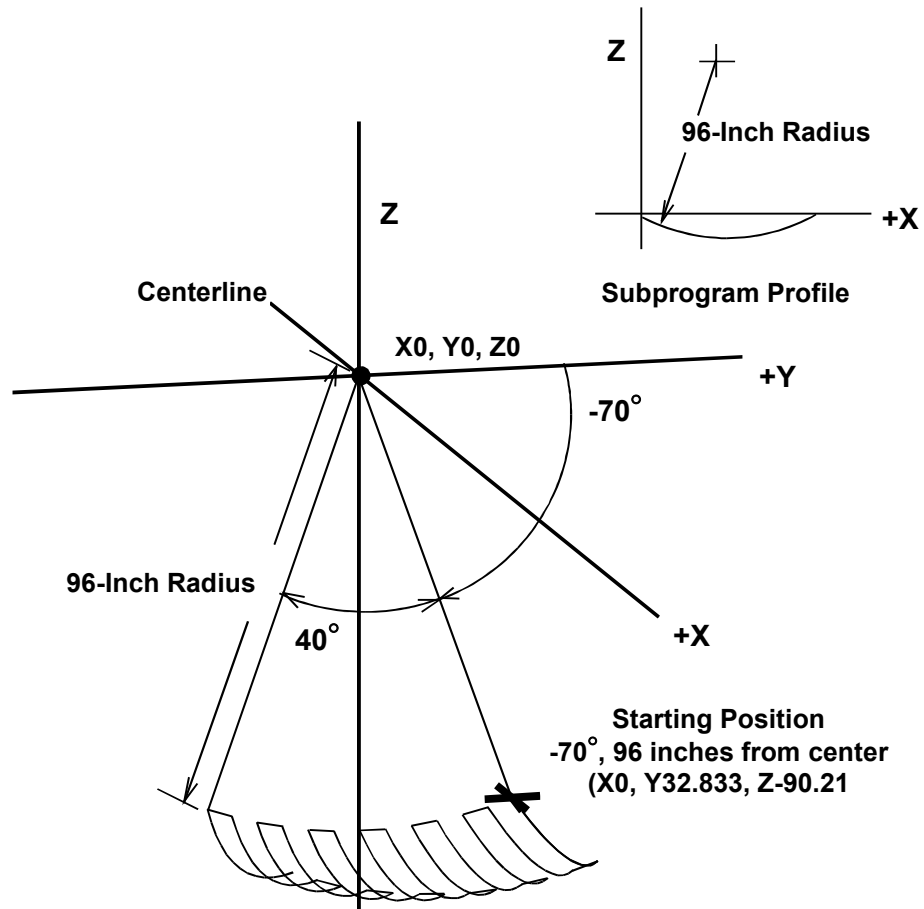

LG-RAD2

**Figure 4-39, Large Radius Mold Rotation**

If the rotation is less than 180 degrees, a point on the start angle that is a specified distance from the centerline defines the starting position.

**TIP:** Use the Geometry Calculator to determine this position (refer to ["Section 6 - Calculators"](#)).

### Rotation Around the Z-Axis

The centerline of rotation is parallel to the Z-axis (**AxisRot**). The **BAxisCL** and **CAxisCL** values are the X and Y coordinates of the centerline. Type the X coordinate in the **BAxisCL** field and the Y coordinate in the **CAxisCL** field. Refer to **Figure 4-40**.

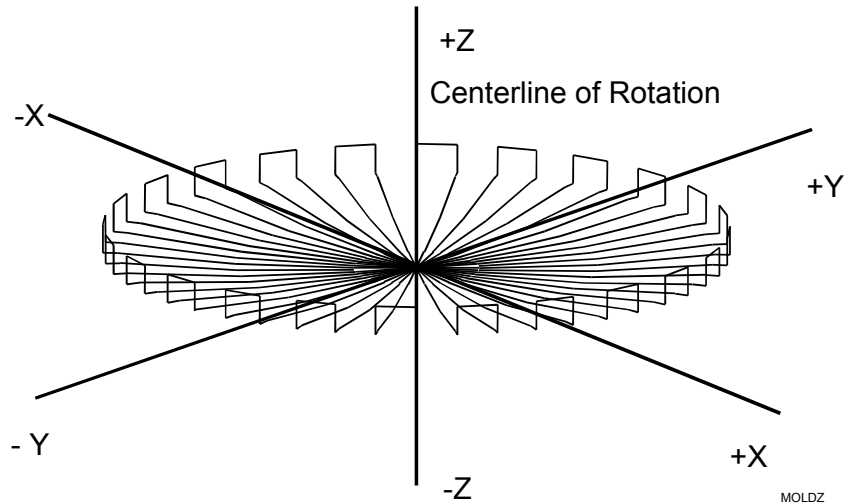

**Figure 4-40, Z-Axis Mold Rotation**

Position the machine at the center of rotation at cycle starts. The finished shape centers on the starting position. The Z-axis position of the starting point determines the Z-axis position of the finished shape.

Restrict subprogram moves for Z-axis rotations to the +X half of the XZ plane. Rules for using tool compensation are the same as those for X- and Y-axis rotations. Refer to **Figure 4-41**.

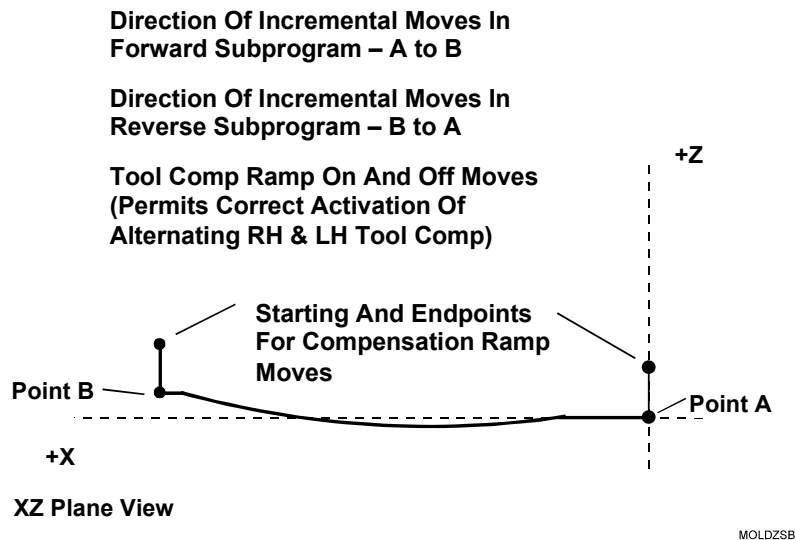

**Figure 4-41, Z-Axis Rotation Subprogram Details**

**Figure 4-42** defines the Z-axis rotation start and end angles.

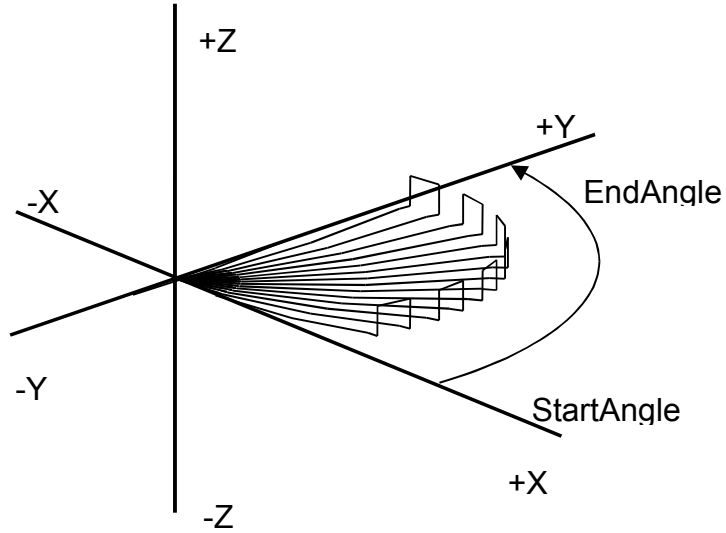

**Figure 4-42, Z-Axis Rotation Start and End Angles**

To program a **MoldRot** block:

1. In Edit Mode, press **Pocket (F4)** to display a pop-up menu.
2. Highlight **Mold Rotation** and press **ENTER** to display the **MOLD ROTATION** Graphic Menu. Refer to **Figure 4-43**.

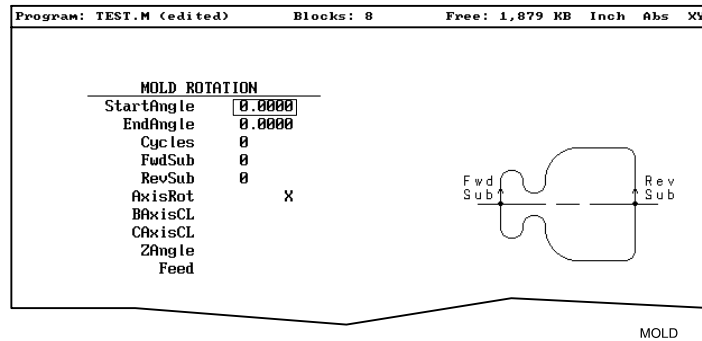

**Figure 4-43, MOLD ROTATION Graphic Menu**

3. Fill in the **MOLD ROTATION** entry field:

- |                   |   |
|-------------------|---|
| <b>StartAngle</b> | Absolute starting angle of the rotation. Value required.                            |
| <b>EndAngle</b>   | Absolute final angle of the rotation. Value required.                               |
| <b>Cycles</b>     | Number of subprogram cycles executed between start and stop angles. Value required. |
| <b>FwdSub</b>     | Forward subprogram call. Value required.  |
| <b>RevSub</b>     | Reverse subprogram call. Value required.  |
| <b>AxisRot</b>    | Axis of rotation. Press +/- to toggle the selection. Selection required.            |
| <b>BAxisCL</b>    | First position coordinate of the rotated axis. Optional.                            |

<b>CAxisCL</b>	Second position coordinate of the rotated axis. Optional.
<b>ZAngle</b>	Rotated position of XY axis mold. Optional.
<b>Feed</b>	Feedrate. Optional.

**NOTE:** After you program a mold rotation, activate the plane required for subsequent moves.

**Programming an Elbow Milling Cycle**

Elbow Milling cycles simplify the programming required to mill elbow-shaped cavities and cores. Finished elbows can have the same radius at each end (bent cylindrical shape) or a different radius at each end (bent conical shape). Refer to **Figure 4-44**.

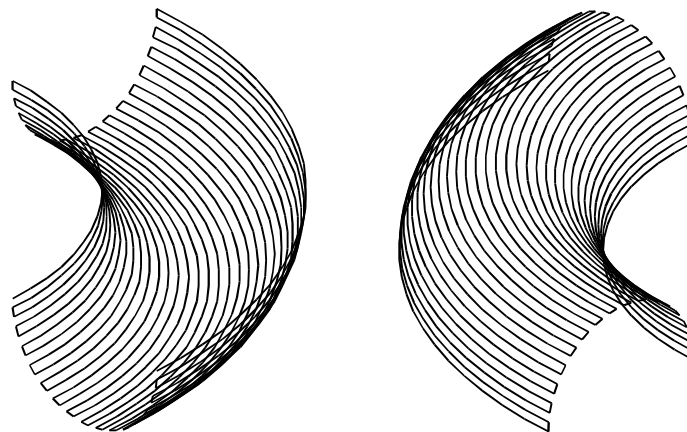

**Figure 4-44, Elbow Cavity and Core**

The Elbow Milling Cycle starts at the machine's present position. The CNC executes passes back and forth around the elbow's inner radius, from the start radius to the end radius. The tool advances to the cavity (or around the core) at the end of each pass until the elbow is completed. The cycle stops at the opposite side of the elbow, at the same Z-axis position from which it started. Refer to **Figure 4-45**.

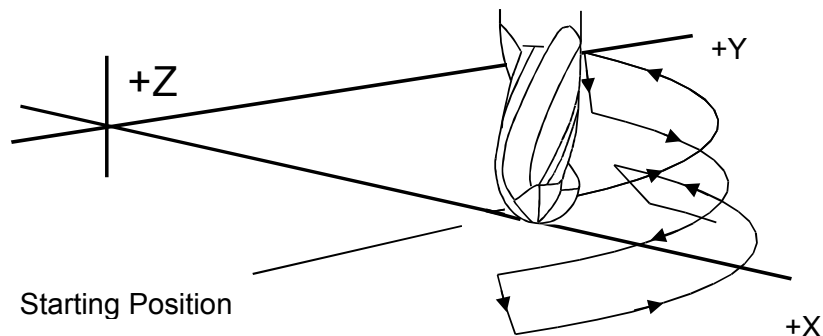

CW Execution Of Moves For Elbow Cavity

**Figure 4-45, Execution of Elbow Milling Cycle Moves**



Do not use tool compensation with the Elbow Milling Cycle. When cutting a particularly deep elbow, it may be necessary to cut the shape in several passes. It is easiest to program the elbow in a subprogram. The main program should consist of moves that position the machine at consecutively lower Z-axis starting positions. Call the subprogram at each successive starting position.

Consider the starting position of the machine when programming an Elbow Milling Cycle. The distance between the starting point and the **XCenter**, **YCenter** determines the elbow's inner radius. The line between the starting point and the **XCenter**, **YCenter** is the zero degree reference for the included angle. When **XCenter**, **YCenter** values are blank, the CNC uses X0, Y0 (default) values. Refer to **Figure 4-46**.

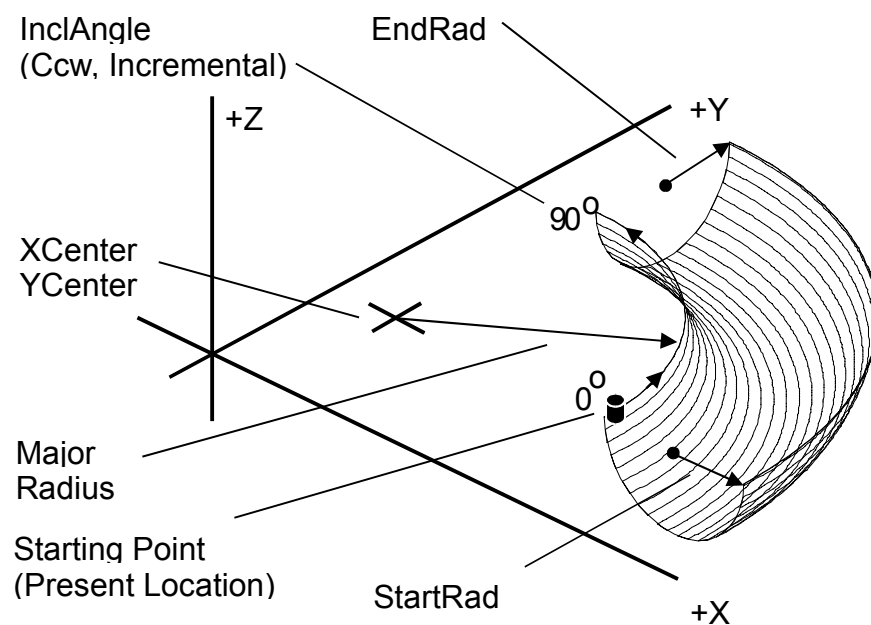

**Figure 4-46, Elbow Milling Cycle Details**

When the line between the starting point and the **XCenter**, **YCenter** does not lie along the X- or Y-axis, the orientation of the finished elbow will shift around the XY center accordingly. Refer to **Figure 4-47**.

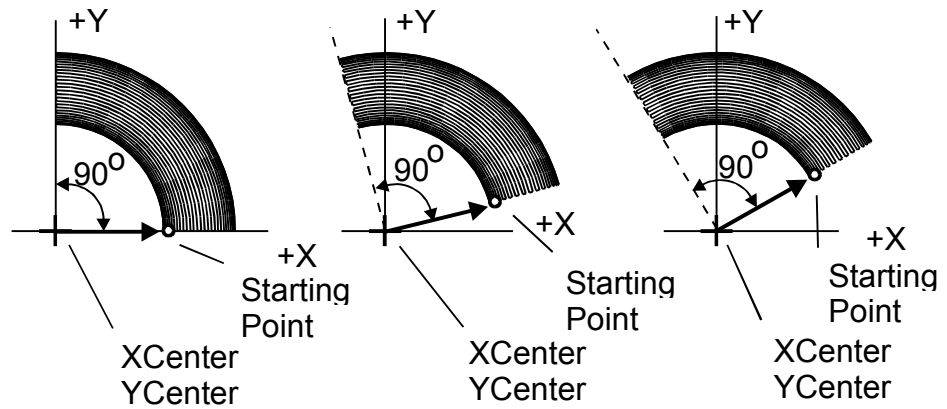

**Figure 4-47, Starting Point and Effect on Orientation**

The distance between the starting point and the XY center determines the elbow inner radius. Moving the starting point away from the XY center increases the overall size of the finished elbow, as shown. Refer to **Figure 4-48**.

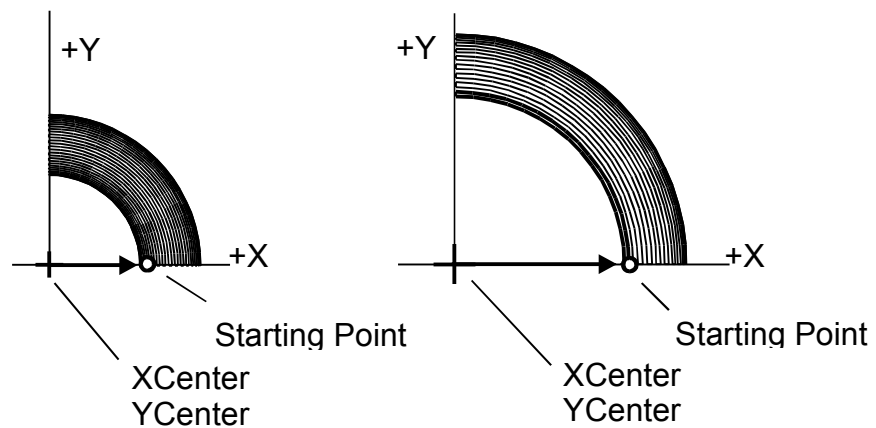

**Figure 4-48, Starting Point and Effect on Size**

The **Cycles** value determines the number of passes used to cut the elbow. Type a negative cycle value to cut a core (above the XY plane). Use a positive cycle value to cut a cavity (below the XY plane). Refer to **Figure 4-49**.

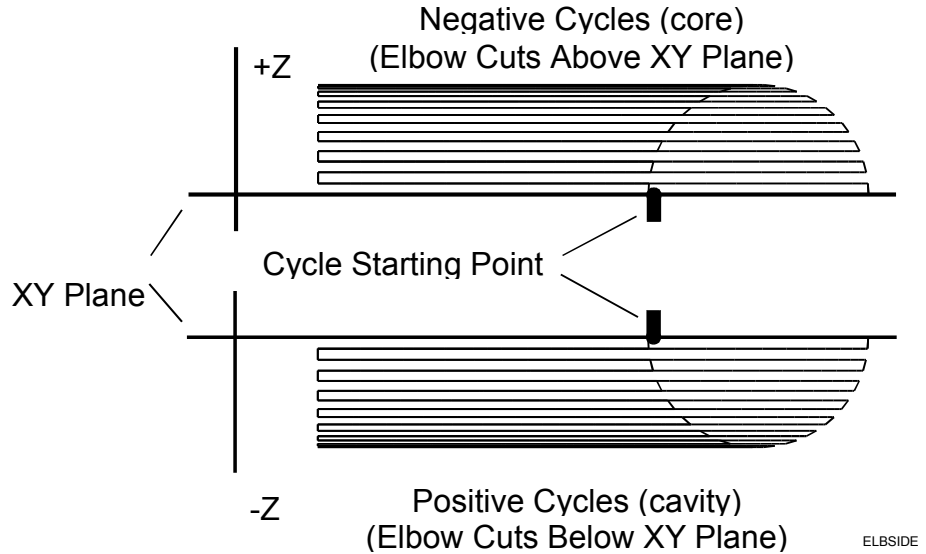

**Figure 4-49, Core and Cavity Detail**

Program an Elbow Milling Cycle with unequal **StartRad** and **EndRad** values to produce a conical elbow. Refer to **Figure 4-50**.

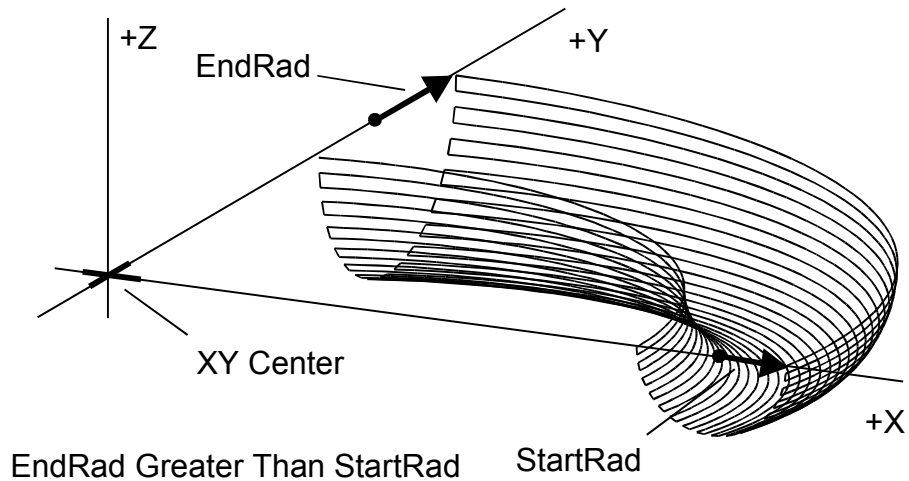

**Figure 4-50, Conical Elbow Details**

To program an Elbow Milling cycle:

1. In Edit Mode, press **Pocket (F4)** to display a pop-up menu.
2. Highlight **Elbow Milling** and press **ENTER** to display the **ELBOW MILLING** Graphic Menu. Refer to **Figure 4-51**.

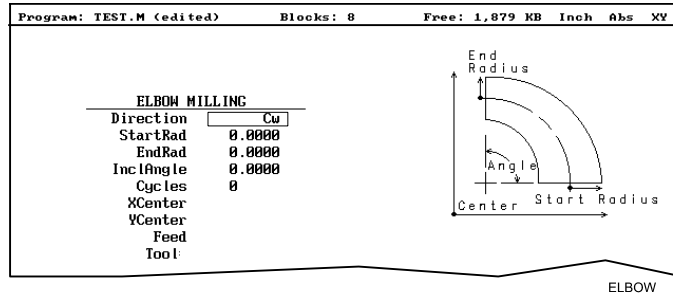

**Figure 4-51, ELBOW MILLING Graphic Menu**

3. Type **ELBOW MILLING** entry fields:

<b>Direction</b>	Direction, clockwise ( <b>Cw</b> ) or counterclockwise ( <b>Ccw</b> ), of first pass from starting point. Press +/- to toggle the selection. Selection required.
<b>StartRad</b>	Radius of the cavity/core at the starting end of the elbow. Value required.
<b>EndRad</b>	Radius of the cavity/core at the far end of the elbow. Value required.
<b>InclAngle</b>	Angle (centered at XY center) between the <b>StartRad</b> end and the <b>EndRad</b> end of the elbow. Value required.
<b>Cycles</b>	The number of passes used to cut the elbow. Value required.
<b>XCenter</b>	X coordinate of the elbow's inner radius center point. Optional.
<b>YCenter</b>	Y coordinate of the elbow's inner radius center point. Optional.
<b>Feed</b>	Feedrate. Optional.

### Engraving, Repeat, and Mill Cycles

This section describes operation of three new cycles:

- [Engraving Cycle](#)
- [Repeat Cycle](#)
- [Mill Cycle](#)

#### Engraving Cycle

The Engraving cycle provides a quick and easy way to engrave part numbers, legends, or any alpha/numeric inscription. The usual type of cutter is a sharp point or center-drill type tool. Options are given for engraving on an angle and mirror is supported for engraving molds. When executed, the CNC rapids to the start point, then to the StartHgt. It then feeds to the Zdepth specified and begins cutting the Text selected.

#### Programming the Engraving Cycle

To program the Engraving Cycle:

1. In Edit mode, press **Mill (F5)** and **More (F7)** to display the More pop-up menu, **Figure 4-52**. Highlight **Engrave** and press **ENTER** to display the Engraving Cycle screen, [Figure 4-53, Engraving Cycle Screen](#).
2. Complete the entry fields (refer to [Table 4-3, Engraving Cycle Entry Fields](#)), and press **ENTER**.

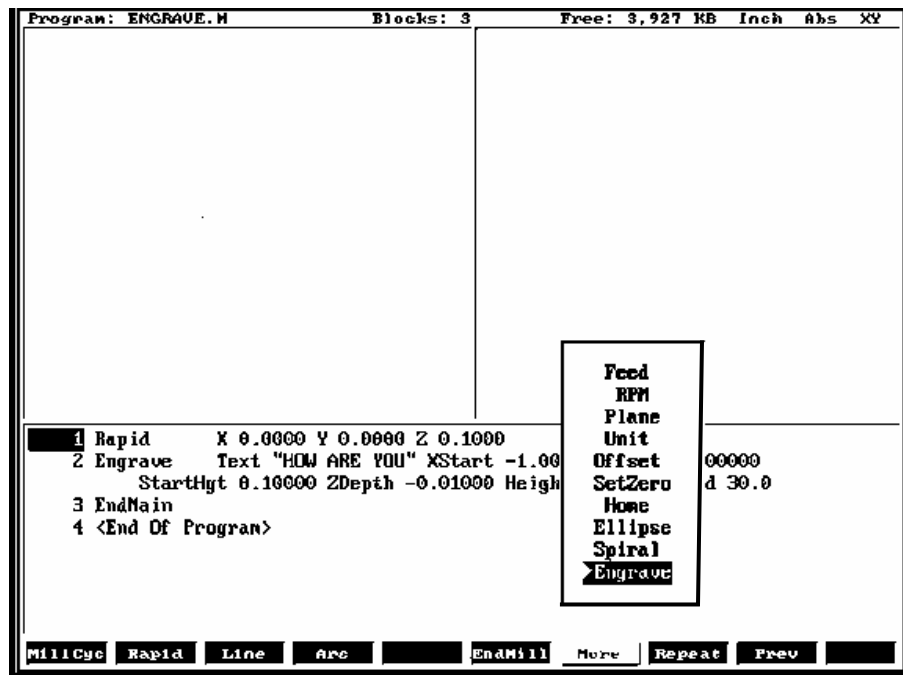

Figure 4-52, More Pop-up Menu

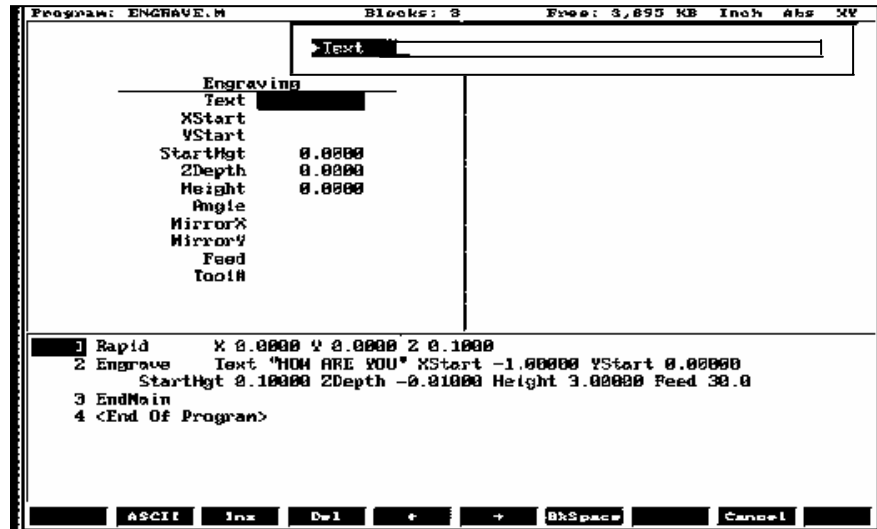

Figure 4-53, Engraving Cycle Screen

Table 4-3, Engraving Cycle Entry Fields

Entry Fields	Description
Text	When the cursor is on Text, it displays an entry field for the letters to be engraved. Letters A – Z, numbers 0 – 9, and: space, ampersand, plus, minus, comma, period, and slash right are supported. No lower case letters are allowed. Press ENTER to accept the text. [Required]
XStart	X coordinate for lower-left corner of the text. Defaults to current position if not given. [Optional]
YStart	Y coordinate for lower-left corner of the text. Defaults to current position if not given. [Optional]
StartHgt	Z absolute start height. Must be higher than Zdepth. [Required]
Zdepth	Z absolute depth of engraving. Must be below StartHgt. [Required]
Height	Letter height. Width will be proportional to height. Height is measured at the centerline of the cutter. [Required]
Angle	Angle in degrees. Default is 0 degrees. [Optional]
MirrorX	Mirrors all X moves. Set by using minus key (-) while in this field. [Optional]
MirrorY	Mirrors all Y moves. Set by using minus key (-) while in this field. [Optional]
Feed	Feedrate used while engraving. Default is current feedrate. [Optional]
Tool#	Active Tool [Optional] Used only on 3000M controls – not on 6000M

### Sample Engraving Cycle Program

```

1   Dim Abs
2   Unit Inch
3   Rapid   X 0.00000 Y 0.00000
4   Tool# 1
5   Rapid   X 1.00000 Y 1.00000
6   Rapid   Z 0.10000
7   Engrave Text "ABCD" StartHgt 0.0100 ZDepth -0.0100 Height 0.5000
8   Rapid   Z 1.00000
9   Rapid   X 0.00000 Y 0.00000
10  EndMain
    
```

This program will rapid to X1.0 Y1.0. Z will rapid to 0.1 and the letters ABCD will be engraved 0.0100" deep and 0.500" high.

### Repeat Cycle

The Repeat cycle allows a series of previously programmed blocks to be repeated. Some examples are going over the same contour while lowering the Z-axis, or drilling over a series of holes with a different drill cycle, or moving an operation to a different location using fixture offsets. Wherever it is used, the repeated blocks will be processed, just as if they were written in the program at that point.

### Programming the Repeat Cycle

To program the Repeat Cycle:

1. In Edit mode, press **Mill (F5)** and **Repeat (F8)** to display the Repeat Cycle screen, **Figure 4-54**.

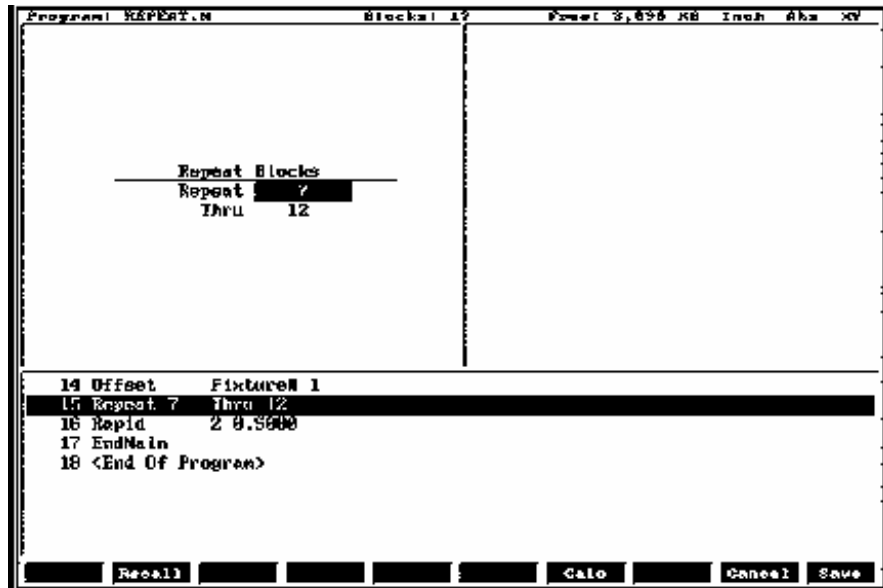

Figure 4-54, Repeat Cycle Screen

2. Complete the entry fields (refer to **Table 4-4**), and press **ENTER**.

**Table 4-4, Repeat Cycle Entry Fields**

Entry Field	Description
<b>Repeat</b>	Type the block number you want to begin repeating. [Required]
<b>Thru</b>	Type the block number you want to end the repeat. [Required]

3. When using a Modal Drilling Cycle with the Repeat feature, a **DrillOff** or non-move command must be included as the final block. For example, see “Sample Repeat Cycle Program” block 7–12 and block 15.

**Sample Repeat Cycle Program**

```

1   Dim Abs
2   Unit Inch
3   Offset  Fixture# 0
4   Rapid   X 0.0000 Y 0.0000
5   Tool# 1
6   Rapid   Z 0.1000
7   BasicDrill ZDepth -0.50000 StartHgt 0.10000 Feed 15.0
8   Rapid   X 1.00000
9           Y 1.0000
10          X 0.0000
11          Y 0.0000
12  DrillOff
13  Offset  Fixture# 1 X 3.0000 Y 0.0000
14  Offset  Fixture# 1
15  Repeat 7 Thru 12
16  Rapid   Z 0.5000
17  EndMain
    
```

This program will drill four holes. A Fixture Offset is used to relocate X Y zero. When the Repeat Cycle is encountered, it will drill four more holes at the offset location.



### Mill Cycle

The Mill cycle is intended for contour milling operations. Cutter compensation, Z pecking, Z finish stock, RoughFeed, and FinishFeed are supported. The cycle will rapid to the XY start point (compensated, if comp is on) rapid to the start height and then feed to the Zdepth or DepthCut using the Zfeed. Subsequent milling blocks are then executed using the ToolComp parameter and Feed specified. The feedrate can be changed in the blocks that are being milled, but not Cutter Comp. The cycle is terminated with the EndMill block at which point it rapids up to the StartHgt and returns to the un-comped XStart YStart location.

### Programming the Mill Cycle

To program the Mill Cycle:

1. In Edit mode, press **Mill (F5)** and **MillCyc (F1)** to display the Mill Cycle screen, **Figure 4-55**.
2. Complete the entry fields (refer to [Table 4-5, Mill Cycle Entry Fields](#)), and press **ENTER**.

### Programming the EndMill Block

To program the EndMill Block:

1. In Edit mode, press **EndMill (F6)** to end the cycle.

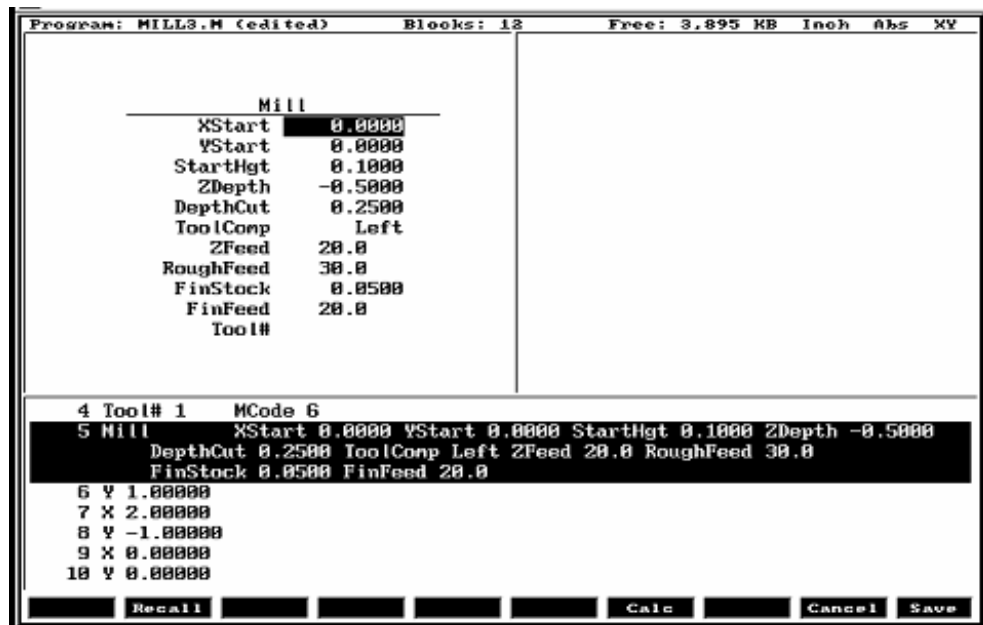

Figure 4-55, Mill Cycle Screen

**Table 4-5, Mill Cycle Entry Fields**

Entry Field	Description
<b>XStart</b>	X coordinate for start of Mill cycle. Defaults to current position if not given. [Optional]
<b>YStart</b>	Y coordinate for start of Mill cycle. Defaults to current position if not given. [Optional]
<b>StartHgt</b>	Z absolute start height. Must be 0.100" above work surface (0.2mm). [Required]
<b>ZDepth</b>	Absolute depth of finished contour. [Required]
<b>DepthCut</b>	Depth of cut taken in a single pass. Cuts will be adjusted so that all are equal pecks. [Optional]
<b>ToolComp</b>	Tool radius compensation Left or Right of programmed path. Set by using minus key (-) while in this field. [Optional]
<b>ZFeed</b>	Feedrate for Z-axis. Defaults to current feedrate. [Optional]
<b>RoughFeed</b>	Feedrate for X and Y-axis. Defaults to current feedrate. [Optional]
<b>FinStock</b>	Amount of stock to take for last Z peck. [Optional]
<b>FinFeed</b>	Feedrate used for FinStock. [Optional]
<b>Tool #</b>	Active Tool. [Optional] Used only on 3000M controls – not on 6000M

**Sample Mill Cycle Program**

```

1   Dim Abs
2   Unit Inch
3   Rapid   X 0.00000 Y 0.00000
4   Tool# 1   MCode 6
5   Mill    XStart 0.00000 YStart 0.00000 StartHgt 0.10000
        ZDepth -0.50000 DepthCut 0.25000 ToolComp Left ZFeed 20.0
        Feed 30.0
6   Y 1.00000
7   X 2.00000
8   Y -1.00000
9   X 0.00000
10  Y 0.00000
11  EndMill
12  EndMain
    
```

This program will contour a square, in two Z pecks of 0.250" each. The blocks 6 thru 10 are the contour moves that will be comped to the left of tool path direction. Block 11, EndMill is required to show the end of the contour. The cutter will be returned to the start point, X0 Y0 at the start height of 0.100".

## Probing Cycles

Probing cycles have the following features:

- ❑ [Tool probe cycles](#)
- ❑ [Spindle probe cycles](#)

This section describes operation and an overview of the tool and spindle probe canned cycles in conversational format. Probing is an:

- Option in 5000M CNC system
- Standard in 6000M CNC system

The cycles provided perform the most common tool and spindle probing functions. If Probing has been added post-sale, besides Setup Utility changes, there may be Integral Programmable Intelligence (IPI) program modifications required.

The tool probe cycles are only supported on machines with automatic spindle forward/reverse and spindle speed, and homing with a permanent X, Y, and Z machine position. The method described assumes the use of negative tool-length offsets. In this method, the Tool-Length Offset (TLO) in the length column for each tool represents the distance from the tool tip at machine home to top of work piece and is a negative number. This method does not require the use of any Z work coordinate offset to be active. This procedure will find the effective tool diameter by turning the spindle on in reverse and touching two sides of the probe stylus, then storing the tool's diameter in the tool's diameter offset table.

The spindle probing cycles are designed to assist in part setup. Using these cycles, one or more features (edges) of a part can be measured. Using the data obtained with these measurements, calculations are made that can be used to set a given fixture offset. It is also possible to find the orientation angle of a part so as to not always have to align the part exactly.

Tool and spindle probing do not allow rotation, scaling, and mirroring. Plane will be set to XY when these cycles are complete.

## Tool Probe Cycles

Before using your tool probe and tool probe cycles, you must setup the probe following the probe manufacturer's specifications.

The tool probe will update the tool registers only. If you are going to use the tool being measured after the probing cycle, you must recall that tool for the new offsets to be active.

This section covers the following topics:

- ❑ [Tool Probe cycle designations](#)
- ❑ [Description of tool probe cycles](#)

For probing system parameter setup information, refer to:

- [5000M CNC Setup Utility Manual, P/N 70000509, “Section 2 – Builder Setup,” “Probing”](#)
- [6000M CNC Setup Utility Manual, P/N 70000490, “Section 2 - Machine Constants,” “MC\\_1150 to MC\\_1165”](#)

### Tool Probe Cycle Designations

The following summarizes the cycles available:

**Probe Calibration  
(CalibTIPrb)**

**Tool Probe Calibration Cycle**

This is used to set the Z datum for length preset, the effective probe stylus diameter for setting tool diameter registers, and establishes the center of the probe stylus.

**NOTE:** Calibration must be done at least once before using the tool probe. Once the probe has been calibrated, calibration does not need to be done again unless the probe is moved or a new part is being setup. The cycle must always know the relationship between the top of the part and the top of the probe to set the TLO.

**Length and Diameter  
(LenDiamMea)**

**Tool Length and Diameter Offset Preset**

Updates length and diameter tool registers.

**NOTE:** If the tool has a hole on the bottom so that the probe would fall between the tool teeth, do not use this cycle. Damage to the probe could result. In this case, use **Length Special** for manual length preset or **Diameter Special** for manual diameter preset.

**Length Special  
(LenSpecMea)**

**Manual Tool-Length Offset Preset**

Updates tool-length register. To be used for large face mill style tools or shell mill tools that have a hole in the center of the bottom of the tool.

**Diameter Special  
(DiaSpecMea)**

**Manual Tool Diameter Preset**

Updates tool diameter register for irregular shaped tools or tools with a hole in the center of the bottom.

**Break and Wear  
(BrkWearDet)**

**Tool Breakage, Length and Diameter Wear Detection  
Breakage**

Checks the tool and gives an alarm if not within tolerance.

Length and Diameter Wear – Check the Length and/or Diameter and updates the Length and/or Diameter wear registers up to a user-defined limit. Once the user-defined limit has been reached, the cycle will give an alarm and stop the program.

### Description of Tool Probe Cycles

- For tool probing or tool length presetting, Tool-Length Offset (TLO) is the distance from machine home to top of work piece or wherever you set your part “**Z**” zero.
- Before starting to set your tools, you must calibrate the probe. Once the probe has been calibrated, calibration does not have to be done again unless you remove the probe or replace the stylus.
- Recalibration may also be required if the Z location of the top of the part changes, and is not compensated for by a Z work offset.
- The probing cycles can be found in the conversational side of the 5000M and 6000M by pressing **Mill (F5)**, then **Probe (F10)** and **ToolPro (F1)** or **SpinPro (F3)**. You can also access the probe cycles on the 5000M and 6000M from the main edit screen by pressing the **SHIFT** key and then **F1** or **F3**.

The following sections contain detailed descriptions of the tool probe cycles:

- [Tool Probe Calibration Cycle \(CalibTIPrb\)](#)
- [Tool Length and Diameter Offset Preset \(LenDiamMea\)](#)
- [Manual Tool Length Measure for Special Tools \(LenSpecMea\)](#)
- [Manual Tool Diameter Measure for Special Tools \(DiaSpecMea\)](#)
- [Tool Breakage, Length, and Diameter Wear Detection \(BrkWearDet\)](#)

**Tool Probe Calibration Cycle (CalibTIPrb)**

**Format:** CalibTIPrb DiamOfStd(n) DistDown(n)

This cycle is used to calibrate the probe. This sets the Z datum for length preset to the top of the part, establishing the center of the probe stylus, and the effective probe stylus diameter for setting tool diameter registers. Refer to **Table 4-6**.

**Table 4-6, CalibTIPrb Entry Fields**

Entry Fields	Description
<b>DiamOfStd</b>	The diameter of the part of the calibration standard that comes in contact with the probe stylus during calibration. This should be an exact measurement. (Optional override for <b>Diameter of tool probe gauge</b> )
<b>DistDown</b>	The distance to go down along the side of the probe stylus with the probe calibration standard when touching the side of the stylus for diameter calibration. The maximum <b>DistDown</b> value is 0.55" (13.97 mm). Without any <b>DistDown</b> value, the cycle will bring the calibration standard down past the top of the probe stylus the default 0.1" (2.54mm). If you put a number higher than 0.55" (13.97 mm), the control displays an error. (Optional) [Default: 0.1"]

To calibrate the tool probe:

1. Jog the calibration standard (the calibration standard should be in the spindle) to the top of your work piece, and set its tool-length offset to the top of the work piece or to wherever you would like your Z zero to be. To calibrate the tool number:
  - a) Jog the tip of the calibration standard to the proper spot
  - b) Press the **Calib Z** function key.
2. Manually jog the calibration standard over the probe stylus center and less than 0.1" (2.54 mm) above the probe stylus. It should be no more than 0.1" (2.54 mm) from the center of the stylus.
3. From the MDI mode, pick **F5 (Mill) > F10 (Probe) > F1 (ToolPro) > Probe Calibration**  
For example: **CalibTIPrb** exit by pressing **F9** twice and **F10** to exit.
4. The Z-axis will initially go down and touch the top of the probe stylus at the feedrate specified in "**Z first pick, MEDIUM feedrate**" machine setup parameter. Then retouch at the slow feedrate, "**Z final pick, SLOW feedrate**" machine setup parameter, establishing the zero probe stylus top.
5. Then incrementally rapid up whatever value that is in "**Z retract distance**" machine setup parameter.

6. The spindle will come on at the RPM specified at the “**RPM for calibration and tool measurement**” machine setup parameter and then the calibration standard will move over an incremental amount that is equal to (Half the value entered in the **DiamOfStd** cycle parameter (or machine setup parameter Diameter of probe gauge) + Half the value entered in “**Nominal probe stylus diameter**” machine setup parameter + The value in the “**XY retract distance**” machine setup parameter). The direction the probe will move over depends on what is placed in the “**Probe orientation**” machine setup parameter:
  - 1 Go first to the left
  - 1 Go first to the right
  - 2 Go first to the front
  - 2 Go first to the back
7. The Z-axis will then do a guarded Z move down 0.1” (2.54 mm) or whatever amount was placed in the **DistDown** cycle parameter and then move over toward the probe stylus 0.3” (7.62 mm) or until it touches the probe stylus. If contact is not made with the probe or if contact is made during a guarded move, then an alarm will be generated and the canned cycle will terminate.
8. After the probe stylus is touched on the first side, the machine will then rapid up and over the stylus then down on the opposite side then over to the other two sides until it has touched the probe stylus on all four quadrants. This will establish the center of the probe stylus.
9. The spindle will then turn off and the machine will touch off on two sides of the probe with the spindle off finding the effective probe stylus diameter. Then, will rapid up above the probe stylus and over to the center.
10. Remove the calibration standard. You are now ready to start running the **Length and Diameter** cycle (or one of the other cycles for setting or checking length and diameter of the tool) to set your tool-length offsets or tool diameter registers.

**Tool Length and Diameter Offset Preset (LenDiamMea)**

**Format:** LenDiamMea Tool#(tool#) EstDiam(n) MeasType (Length, Diameter, or Both) DistDown(n) OvrFstFeed(n) OvrMedFeed(n) OvrSlwFeed(n) OvrRPM(n)

Each tool must have the length set once before trying to set the diameter. Call this cycle up the first time using **Both** because it will automatically set the length first then the diameter.

- ❑ Calibrate the tool probe at least once before trying to automatically preset a tool. This is done initially, but if the stylus is ever changed or the probe is moved, then you must again calibrate the tool probe.
- ❑ This tool preset (**LenDiamMea**) can be run from within a program or from the MDI mode. Refer to **Table 4-7**.

**Table 4-7, LenDiamMea Entry Fields**

Entry Fields	Description
<b>Tool#</b>	Tool number. (Required)  With only the <b>Tool#</b> cycle parameter present, the canned cycle will not step over half the tool’s diameter but come straight down measuring the tool length and storing it in the tool register.
<b>EstDiam</b>	This is the rough diameter of the tool. This should be within 0.04” (1.0 mm). (Optional)  If the <b>EstDiam</b> cycle parameter is present, the tool will step over half of its diameter, the spindle will turn on in reverse and then the canned cycle will measure the tool’s length.  A negative <b>EstDiam</b> value is for a left-handed tool and will cause the spindle to come on forward instead of reverse.  For on center length measurement, do not give a <b>EstDiam</b> cycle parameter.
<b>MeasType</b>	The option specifies to measure length, diameter, or both and the appropriate tool registers are updated. (Optional) [Default: <b>Length</b> ]  <b>Diameter</b> Measure the diameter only <b>Length</b> Measure the length only <b>Both</b> Measure both length and diameter  If <b>Length</b> is not set, the cycle will measure the tool length only.  If <b>Diameter</b> or <b>Both</b> are programmed, you must also have a <b>EstDiam</b> cycle parameter or the control will display an error message.

*(Continued...)*



**Table 4-7, LenDiamMea Entry Fields (Continued)**

Entry Fields	Description
<b>DistDown</b>	<p>The distance to go down along the side of the probe stylus when doing a diameter pick. The maximum <b>DistDown</b> value is 0.55" (13.97 mm) or the tool may crash into the probe or table. If you enter a value larger than 0.55" (13.97 mm), the control will issue an error message. If <b>DistDown</b> is not set, the cycle will use a default value of 0.1" (2.54 mm). (Optional) [Default: 0.1"]</p> <p>Ball nose cutters and special cutters that require a move down more than 0.55" (13.97 mm) are not supported.</p>
<b>OvrFstFeed</b>	<p>This is the override for the fast Z feedrate that was set in the machine setup parameter "<b>Z first pick, FAST feedrate</b>". Sometimes there may be a tool that has a large diameter making it necessary to slow it down to prevent the touch probe from being hit too hard. This can only be set slower. Trying to set this higher will only result in the software using the original feedrate. (Optional)</p>
<b>OvrMedFeed</b>	<p>This is the override for the medium feedrate that was set in the machine setup parameter "<b>Z first pick, MEDIUM feedrate</b>". This is used for the same reason as the <b>OvrFstFeed</b> cycle parameter. This can only be set slower. Trying to set this higher will only result in the software using the original feedrate. (Optional)</p>
<b>OvrSlwFeed</b>	<p>This is the override for the slow feedrate that was set in the machine setup parameter "<b>Z final pick, SLOW feedrate</b>". This is used for the same reason as the <b>OvrFstFeed</b> cycle parameter. This can only be set slower. Trying to set this higher will only result in the software using the original feedrate. (Optional)</p>
<b>OvrRPM</b>	<p>This is the override for the RPM that was set in the machine setup parameter "<b>RPM for calibration and tool measurement</b>". This is used for the same reason as the <b>OvrFstFeed</b> cycle parameter. This can only be set slower. Trying to set this higher will only result in the software using the original RPM. (Optional)</p>

To use the tool preset probing cycle:

1. Install all the tools you wish to set, in the tool changer.
2. Input:  
LenDiamMea Tool#(tool#) EstDiam(tool rough diameter) MeasType

If run from the inside of a program, this line needs to be repeated for every tool that you want to set.

3. Execute that line if you are in MDI mode, or run the program if you have set all the tools up in a program.
4. If you have done a single tool in MDI mode, that tool is now measured and you are ready to measure the next tool. If you have placed multiple lines in a program, one for each tool, all your tools are measured and ready for use.

Shell mill style tools that have a hole in the center of the bottom will not work with this canned cycle; in this case, you must use the manual canned cycles **LenSpecMea (Length Special Manual Tool Length Measure for Special Tools)** for length and **DiaSpecMea (Diameter Special Manual Tool Diameter Measure for Special Tools)** for diameter. See [Table 4-7, LenDiamMea Entry Fields](#). This cycle is only good for drills, taps, reamers, ball nosed endmills, and standard endmills with a flat bottom, the cycle updates length and diameter tool registers clearing anything in the wear registers.

**Format: LenDiamMea Tool#(tool#)**

With **Tool#** parameter only set:

1. The machine will rapid the Z-axis up and pick up the tool designated in the **Tool#** cycle parameter and rapid directly over the center of the probe stylus.
2. The Z-axis will rapid down the distance placed in the “**Z rapid to start position from home**” machine setup parameter, then start feeding down toward the probe for the initial touch at the feedrate that was placed in the “**Z first pick, FAST feedrate**” machine setup parameter, then will back up and retouch the probe at the feedrate that is in the “**Z final pick, SLOW feedrate**” machine setup parameter.
3. The tool-length register for that tool is now updated, and that tool’s length-wear register is set to zero.
4. Then the Z-axis will rapid up to home position.
5. If you have done a single tool in MDI mode, that tool is now measured and you are ready to measure the next tool. If you have placed multiple lines in a program, one for each tool, the machine will then grab the next tool and repeat steps 1 through 4 until all the tools have been measured.

**Format:** LenDiaMea Tool#(tool#) EstDiam(tool rough diameter)

With **Tool#** and **EstDiam** parameters only set:

1. The machine will rapid the Z-axis up and pick up the tool designated in the **Tool#** cycle parameter and rapid directly over the center of the probe stylus.
2. The Z-axis will rapid down the distance placed in the “**Z rapid to start position from home**” machine setup parameter then start feeding down toward the probe for the initial touch at the feedrate that was placed in the “**Z first pick, FAST feedrate**” machine setup parameter then will back up.
3. The machine will rapid over half the diameter of the cutter from the probe stylus center in the direction related to the “**Probe orientation**” machine setup parameter.
4. The spindle will then come on in reverse at the RPM specified in the “**RPM for calibration and tool measurement**” machine setup parameter and retouch the probe at the feedrate that is in the “**Z final pick, SLOW feedrate**” machine setup parameter.
5. The tool-length register for that tool is now updated, and that tool’s length-wear register is set to zero.
6. Then the Z-axis will rapid up to the home position.
7. If you have done a single tool in MDI mode, that tool is now measured and you are ready to measure the next tool. If you have placed multiple lines in a program, one for each tool, the machine will then grab the next tool and repeat steps 1 through 6 until all the tools have been measured.

**Format:** LenDiaMea Tool#(tool#) EstDiam(tool rough diameter)  
MeasType (Both)

With **Tool#**, **EstDiam**, and **MeasType** parameters set:

1. The machine will rapid the Z-axis up and pick up the tool designated in the **Tool#** cycle parameter and rapid directly over the center of the probe stylus.
2. The Z-axis will rapid down the distance placed in the “**Z rapid to start position from home**” machine setup parameter then start feeding down toward the probe for the initial touch at the feedrate that was placed in the “**Z first pick, FAST feedrate**” machine setup parameter then will back up.
3. The machine will rapid over half the diameter of the cutter from the probe stylus center in the direction related to the “**Probe orientation**” machine setup parameter.

4. The spindle will then come on counter clockwise at the RPM specified in the “**RPM for calibration and tool measurement**” machine setup parameter and retouch the probe at the feedrate that is in the “**Z final pick, SLOW feedrate**” machine setup parameter.
5. The tool-length register for that tool is now updated, and any value in the length wear register will be reset to zero.
6. Then the Z-axis will rapid up above the probe stylus the distance specified in the “**Z retract distance**” machine setup parameter and then rapid the X & Y axes over the center of the probe and turn the spindle on in reverse.
7. The machine will move the tool’s edge off to one side of the probe stylus in the direction indicated in the “**Probe orientation**” machine setup parameter before making a guarded move down 0.1” (2.54 mm) or whatever value has been placed in the **DistDown** cycle parameter.
8. The machine will then touch the tool to the probe stylus on two opposite sides at the feedrate specified in the “**Z first pick, MEDIUM feedrate**” machine setup parameter with the spindle running at the RPM specified in the “**RPM for calibration and tool measurement**” machine setup parameter, backing up 0.02” (0.508 mm) after each first touch then retouching and the feedrate specified in the “**Z final pick, SLOW feedrate**” machine setup parameter, calculating the diameter of the tool and placing the calculated diameter value in the diameter register for the tool being preset and any value in the diameter wear register will be reset to zero.
9. Then the Z-axis will rapid up to the home position.
10. If you have done a single tool in MDI mode, that tool is now measured and you are ready to measure the next tool. If you have placed multiple lines in a program, one for each tool, the machine will then grab the next tool and repeat steps 1 through 9 until all the tools have been measured.

### Manual Tool Length Measure for Special Tools (LenSpecMea)

**Format:** LenSpecMea Tool#(tool#) DiamOfStd(n) OvrMedFeed(n)  
OvrSlwFeed(n) OvrRPM(n)

This cycle is used to measure the length of large face mill style tools that have a hole in the center of the bottom of the tool. Refer to **Table 4-8**.

**Table 4-8, LenSpecMea Entry Fields**

Entry Fields	Description
<b>Tool#</b>	Tool number. (Required)  With only the <b>Tool#</b> cycle parameter present, the spindle will turn on in reverse and the canned cycle will come straight down measuring the tool length and storing it in the tool-length register. The <b>Tool#</b> cycle parameter must be the same as the current tool in the spindle.
<b>EstDiam</b>	This is the rough diameter of the tool and is only used in this cycle to determine if the spindle should be turned on in reverse or forward. If you have a left-handed tool you would give a negative value to the diameter. If this parameter is left off the control will always turn on in reverse by default. (Optional)
<b>OvrMedFeed</b>	This is the override for the medium feedrate that was set in the machine setup parameter " <b>Z first pick, MEDIUM feedrate</b> ". Sometimes there may be a tool that has a large diameter making it necessary to slow it down to prevent the touch probe from being hit too hard. This can only be set slower. Trying to set this higher will only result in the software using the original feedrate. (Optional)
<b>OvrSlwFeed</b>	This is the override for the slow feedrate that was set in the machine setup parameter " <b>Z final pick, SLOW feedrate</b> ". This is used for the same reason as the <b>OvrMedFeed</b> cycle parameter. This can only be set slower. Trying to set this higher will only result in the software using the original feedrate. (Optional)
<b>OvrRPM</b>	This is the override for the RPM that was set in the machine setup parameter " <b>RPM for calibration and tool measurement</b> ". This is used for the same reason as the <b>OvrMedFeed</b> cycle parameter. This can only be set slower. Trying to set this higher will only result in the software using the original RPM. (Optional)

**Warning:** Large tools can result in probe damage if the touch feedrate is set too fast. For this reason, the parameters: **OvrMedFeed**, **OvrSlwFeed**, and **OvrRPM** have been added to enable the programmer/operator to override the values in the parameters for the specific tool being checked or set.

You must have the tool positioned over the probe stylus so that the tooth that sticks down the furthest is directly over the center of the probe stylus and above the stylus less than 0.200" (5.08 mm).

**NOTE:** If the spindle is locked, you may have to unlock it to manually orient the tool tooth over the probe stylus.

To measure the tool length:

1. Jog the tool to the top of the probe stylus so that the tooth that sticks down the furthest is directly over the center of the probe stylus.
2. From the MDI mode, input:  
  
 LenSpecMea Tool#(tool#) EstDiam(n), Exit and press the **START** button. Where **Tool#** is the tool number and **EstDiam** is roughly the diameter of the special tool.  
 For example: LenSpecMea Tool# 3 EstDiam 3.5
3. The spindle will turn on in reverse and the Z-axis should go down and touch the top of the probe stylus keeping the X and Y position the same then rapid up 0.02" (0.508 mm) and then retouch using the slow feedrate programmed in the machine variables. The cycle will then update the tool-length offset register clearing any value in the length wear register, turn the spindle off and return the tool to the Z height where it started.
4. The Tool Length has been set and you can now change to another tool, and repeat steps 1 through 3.

### Manual Tool Diameter Measure for Special Tools (DiaSpecMea)

**Format:** DiaSpecMea Tool#(tool#) EstDiam(n) DistDown(n)  
OvrMedFeed(n) OvrSlwFeed(n) OvrRPM(n)

This cycle is used to measure the diameter of irregularly shaped tools or tools with a hole in the center of the bottom. Refer to **Table 4-9**.

**Table 4-9, DiaSpecMea Entry Fields**

Entry Fields	Description
<b>Tool#</b>	Tool number. (Required) The <b>Tool#</b> cycle parameter must be the same as the current tool in the spindle.
<b>EstDiam</b>	This is the rough diameter of the tool. (Required) The diameter specified in this parameter should be larger than the actual diameter of the tool being measured but no more than 0.04" (1.0 mm) over. If you have a left-handed tool, you would give a negative value to the diameter so the spindle will turn on in forward direction.
<b>DistDown</b>	The distance to go down along the side of the probe stylus when doing a diameter pick. The maximum <b>DistDown</b> value is 0.55" (13.97 mm) or the tool may crash into the probe or table. If you enter a value larger than 0.55" (13.97 mm), the control will issue an error message. If <b>DistDown</b> is not set, the cycle will use a default value of 0.1" (2.54 mm). (Optional) [Default: 0.1"] Ball nose cutters and special cutters that require a move down more than 0.55" (13.97 mm) are not supported.
<b>OvrMedFeed</b>	This is the override for the medium feedrate that was set in the machine setup parameter " <b>Z first pick, MEDIUM feedrate</b> ". Sometimes there may be a tool that has a large diameter making it necessary to slow it down to prevent the touch probe from being hit too hard. This can only be set slower. Trying to set this higher will only result in the software using the original feedrate. (Optional)
<b>OvrSlwFeed</b>	This is the override for the slow feedrate that was set in the machine setup parameter " <b>Z final pick, SLOW feedrate</b> ". This is used for the same reason as the <b>OvrMedFeed</b> cycle parameter. This can only be set slower. Trying to set this higher will only result in the software using the original feedrate. (Optional)

(Continued...)

**Table 4-9, DiaSpecMea Entry Fields (Continued)**

Entry Fields	Description
<b>OvrRPM</b>	This is the override for the RPM that was set in the machine setup parameter " <b>RPM for calibration and tool measurement</b> ". This is used for the same reason as the <b>OvrMedFeed</b> cycle parameter. This can only be set slower. Trying to set this higher will only result in the software using the original RPM. (Optional)

**Warning:** Large tools can result in probe damage if the touch feedrate is set too fast. For this reason, the parameters: **OvrMedFeed**, **OvrSlwFeed**, and **OvrRPM** have been added to enable the programmer/operator to override the values in the parameters for the specific tool being checked or set.

You must:

- Load the tool in the spindle and call up that tools offset.
- Know the distance from the top of the probe stylus down you will have to move so that the largest part of the tool diameter is even with the side of the probe stylus for diameter measurement. That value will be placed in **DistDown** if different then the default 0.1" (2.54 mm).
- Position the tool over the probe stylus so that the tooth that sticks down the furthest is directly over the center of the probe stylus and above the stylus less then 0.200 (5.08 mm).

To measure the tool diameter:

1. Jog the tool to the top of the probe stylus so that the tooth that sticks down the furthest is directly over the center of the probe stylus.
2. From the MDI mode and the spindle off, input:

DiaSpecMea Tool#(n) EstDiam(n) DistDown(n), exit and press the **START** button. Where **Tool#(n)** is the tool number, **EstDiam(n)** is roughly the diameter of the special tool (this should be larger but not more then 0.100" (2.54 mm) larger), and **DistDown(n)** is the Z-axis move down needed if different then the default 0.100" (2.54mm) so that the largest part of the tool diameter comes in contact with the edge of the probe stylus.

For example:

DiaSpecMea Tool# 3 EstDiam 3.5 DistDown .25  
exit and press the **START** button.



3. The Z-axis will feed down with the spindle on, touching the top of the probe stylus. Once the top of the probe is found, the Z-axis will rapid back up above the probe and move over to one side of the probe stylus. The tool will then move down the distance in **DistDown** or 0.1" (2.54 mm) if **DistDown** is not programmed. Then, with the spindle turning in reverse, the canned cycle will touch the side of the tool to the probe stylus twice on opposite sides establishing the tool's diameter. The new diameter will then be stored in that tool's diameter register and clear any value in the diameter wear register. The Z-axis will rapid up to machine home.
4. The Tool Diameter has now been set and you can change to another tool and repeat steps 1 through 3.

**Tool Breakage, Length, and Diameter Wear Detection (BrkWearDet)**

**Format:** BrkWearDet Tool#(tool#) EstDiam(n) MaxLenAdj(n)  
 MaxDiaAdj(n) DistDown(n) Update(n) OvrMedFeed(n) OvrSlwFeed(n)  
 OvrRPM(n)

Refer to **Table 4-10**.

**Table 4-10, BrkWearDet Entry Fields**

Entry Fields	Description
<b>Tool#</b>	Tool number. (Required)  The <b>Tool#</b> cycle parameter will be the tool number you want checked.
<b>EstDiam</b>	This is the rough diameter on the bottom of the tool. (Optional)  The diameter specified in this parameter should be roughly the diameter on the bottom of the tool that you want to be over the center of the probe stylus. If you have a left-handed tool, you would give a negative value to this diameter so the spindle will turn on forward verses reverse. When stepping over for checking the diameter of the tool, this cycle will use the diameter in the tool table for the tool being checked.
<b>MaxLenAdj</b>	The maximum length wear value limit. The cycle will check to see if the cutter length has changed by more then this amount and will alarm, stopping the program if exceeded. If not set, the cycle will not check the tool length. (Optional)  <b>NOTE:</b> At least one, <b>MaxLenAdj</b> or <b>MaxDiaAdj</b> must be set or the cycle will alarm.
<b>MaxDiaAdj</b>	The maximum diameter wear value limit. The cycle will check to see if the cutter diameter has changed by more then this amount and will alarm, stopping the program if exceeded. If not set, the cycle will not check the tool diameter. (Optional)  <b>NOTE:</b> At least one, <b>MaxLenAdj</b> or <b>MaxDiaAdj</b> must be set or the cycle will alarm.
<b>DistDown</b>	The distance to go down along the side of the probe stylus when doing a diameter check. The maximum <b>DistDown</b> value is 0.55" (13.97 mm) or the tool may crash into the probe or table. If you enter a value larger than 0.55" (13.97 mm), the control will issue an error message. If <b>DistDown</b> is not set, the cycle will use a default value of 0.1" (2.54 mm). (Optional) [Default: 0.1"]  Ball nose cutters and special cutters that require a move down more than 0.55" (13.97 mm) are not supported.

(Continued...)

**Table 4-10, BrkWearDet Entry Fields (Continued)**

Entry Fields	Description
<b>Update</b>	If this is undefined or set to <b>No</b> , the <b>Break and Wear</b> cycle will not update the diameter or length wear register each time it checks a tool. If set to <b>Yes</b> , the cycle will update the wear registers. In both cases the control will alarm when the maximum limit set in <b>MaxLenAdj</b> or <b>MaxDiaAdj</b> has been exceeded. (Optional)
<b>OvrMedFeed</b>	This is the override for the medium feedrate that was set in the machine setup parameter " <b>Z first pick, MEDIUM feedrate</b> ". Sometimes there may be a tool that has a large diameter making it necessary to slow it down to prevent the touch probe from being hit too hard. This can only be set slower. Trying to set this higher will only result in the software using the original feedrate. (Optional)
<b>OvrSlwFeed</b>	This is the override for the slow feedrate that was set in the machine setup parameter " <b>Z final pick, SLOW feedrate</b> ". This is used for the same reason as the <b>OvrMedFeed</b> cycle parameter. This can only be set slower. Trying to set this higher will only result in the software using the original feedrate. (Optional)
<b>OvrRPM</b>	This is the override for the RPM that was set in the machine setup parameter " <b>RPM for calibration and tool measurement</b> ". This is used for the same reason as the <b>OvrMedFeed</b> cycle parameter. This can only be set slower. Trying to set this higher will only result in the software using the original RPM. (Optional)

**Warning:** Large tools can result in probe damage if the touch feedrate is set too fast. For this reason, the parameters: **OvrMedFeed**, **OvrSlwFeed**, and **OvrRPM** have been added to enable the programmer/operator to override the values in the parameters for the specific tool being checked or set.

**Warning:** Running this cycle without first initially setting the length and diameter offset could result in damage to the probe and/or the machine tool. **CalTIPrb (Probe Calibration)** and **LenSpecMea (Length and Diameter) Automatic Tool Length and Diameter set**, or **LenSpecMea (Length Special Manual Tool Length Measure for Special Tools)** and **DiaSpecMea (Diameter Special Manual Tool Diameter Measure for Special Tools)** must be run first before using the **BrkWearDet (Break and Wear)** cycle.

The **Break and Wear** cycle loads the tool, checks, and updates length and diameter wear registers, if specified, until a maximum value is exceeded, then it will alarm out stopping the program.

This cycle can be used in place of calling up a tool before running it.

You must know the distance from the top of the probe stylus down that you will have to move so that the largest part of the tool diameter is even with the side of the probe stylus for diameter measurement. That value will be placed in **DistDown** if different then the default 0.1" (2.54 mm).

To check the tool length and/or tool diameter for wear or breakage:

In place of the usual "**Tool#(tool#) MCode6**" command, use:

```
BrkWearDet Tool#(tool#) EstDiam(n) MJaxLenAdy(n) MaxDiaAdj(n)
DistDown(n) Update(n)
```

at a tool change according to the instructions above and the control will check the tool prior to using it. To activate the new offset wear values you must call that tool with "Tool#(Tool#) MCode6" after this cycle has been run.

### Spindle Probe Cycles

This section describes operation and an overview of the conversational programming spindle probing cycles available in 5000M Probe option and standard available in 6000M.

These cycles are designed to assist in part setup only.

Before using your spindle probe for part setup, you must set the probe up according to the probe manufacturer's specification so it is set to turn on with a signal (if cordless) from the optical module sending unit and to automatically time out after approximately 120 seconds.

Rotation, Mirroring, and Scaling with (RMS) is not allowed while running these cycles. If any of these cycles are in a subprogram, you cannot call them using RMS. Plane will be set to XY when these cycles are complete.

This section contains the following topics:

- [Spindle probe cycle designations](#)
- [Canned cycle parameter settings](#)
- [Description of spindle probe cycles](#)

### Spindle Probe Cycle Designations

The following summarizes the cycles available:

**CalibPtPrb    Spindle Probe Calibration Cycle**  
This is used to set the effective probe stylus diameter and set the compensation factor for any run-out of the probe stylus.

You will also need to calibrate the probe using the **CalibPtPrb** cycle.

**NOTE:** On machines that do not have spindle orientation or if you are using a corded probe or cordless UD probe and cannot orient the spindle 180 degrees during calibration, the spindle probe stylus needs to be indicated true to the spindle centerline. In this case, the accuracy of the spindle probe is only as good as the stylus concentricity to the spindle. Calibration must be done at least once before using the spindle probe. Once calibrated, calibration does not have to be done again unless you replace the probe stylus.

**EdgeFind    Single Surface Measure/Edge Find**  
This cycle will find a single surface and store that surface in a work or fixture offset register if programmed.

**CornerOut    Outside Part Corner Find**  
This cycle will find the X & Y surface on an outside corner of a part and store that location in a work or fixture offset register if programmed.

**CornerIn    Inside Part Corner Find**  
This cycle will find the X & Y surface in an inside corner of a part and store that location in a work or fixture offset register if programmed.

**InOutBoss    Inside or Outside Hole or Boss Center Find**  
This cycle will find the X & Y center of an inside hole or outside standing boss on a part and store that location in a work or fixture offset register if programmed.

**InOutWeb    Inside or Outside Web or Slot Center Find**  
This cycle will find the X or Y center of an inside or outside web or slot on a part and store that location in a work or fixture offset register if programmed. The slot or standing web must be parallel to either the X or Y axes.

- |                  |  |
|------------------|--|
| <b>ProbeMove</b> | <b>Protected Positioning Move</b><br>This cycle allows for safe positioning of the probe around the part and will generate an alarm if an obstruction is encountered.  |
| <b>SkewComp</b>  | <b>Skew Error or Angle Find</b><br>This cycle will make two touches on a surface in the X- or Y-axes and stores the angle relative to the 3 O'clock position. This cycle can also activate <b>SkewComp</b> at the same time as it is measured or in a subsequent call at another place in the program without measuring again. |

### Canned Cycle Parameter Settings

Before you set the cycle parameters for the Spindle probe you must:

- ❑ Know what the exact diameter of the Ring Gauge (calibration standard).
- ❑ Know that the Ring Gauge is a standard that is specifically designed for calibrating the probe. The **GaugeDiam** cycle parameter is the diameter of hole that comes in contact with the probe stylus during calibration and should be an exact measurement.

### Description of Spindle Probe Cycles

This section contains detailed descriptions of the spindle probe cycles:

- [Spindle Probe Calibration \(CalibPtPrb\)](#)
- [Edge Finding \(EdgeFind\)](#)
- [Outside Corner Finding \(CornerOut\)](#)
- [Inside Corner Finding \(CornerIn\)](#)
- [Out/Inside Boss/Hole Finding \(InOutBoss\)](#)
- [Out/Inside Web Finding \(InOutWeb\)](#)
- [Protected Probe Positioning \(ProbeMove\)](#)
- [Skew Error Find \(SkewComp\)](#)

### Spindle Probe Calibration (CalibPtPrb)

**Format:** CalibPtPrbn) Top(n) DistDown(n) DistBack(n) GaugeDiam(n)  
DistInX(n) DistInY(n)

Refer to **Table 4-11**.

**Table 4-11, CalibPtPrb Entry Fields**

Entry Fields	Description
<b>Boss</b>	Set <b>Boss</b> to <b>Yes</b> if you are calibrating to a boss verses a ring gauge; otherwise, do not set or set to <b>No</b> . Default is <b>No</b> . (Optional)
<b>Top</b>	If set to <b>Yes</b> , the cycle will find the top of the part before calibrating the probe. If <b>Boss</b> cycle parameter is set to <b>Yes</b> , " <b>Top</b> " is forced to <b>Yes</b> as well; otherwise, the default is <b>No</b> . (Optional)
<b>DistDown</b>	The distance to go down from the top of the ring gauge or standing boss for calibration. This is only used if the <b>Boss</b> cycle parameter is set to <b>Yes</b> . Without any <b>DistDown</b> value, the cycle will bring the probe down past the top of the ring gauge after finding the top, 0.1" (2.54 mm). Note: If the stylus ball is greater than .2" (5.08 mm), <b>DistDown</b> must be set to at least half the ball diameter. (Optional)
<b>DistBack</b>	The <b>DistBack</b> parameter specifies the distance to back away from the edge for the probe to fast feed to before trying to find it. Default is 0.1" (2.54 mm) if not set. (Optional)
<b>GaugeDiam</b>	The diameter of the ring gauge hole the probe stylus will come in contact with. This is only to override the value in the machine setup parameter " <b>Diameter of spindle probe Gauge</b> " if needed and <u>should be an exact measurement</u> . (Optional)
<b>DistInX</b>	The distance from the starting point to move in the X-axis to find the top of the gauge. The default, if <b>Boss</b> is not set or set to <b>No</b> , is 0.1" (2.54 mm) beyond the edge of the ring gauge hole. If <b>Boss</b> is set to <b>Yes</b> , the default is the current probe position. (Optional)
<b>DistInY</b>	The distance from the starting point to move in the Y-axis to find the top of the gauge. The default is the current probe position. (Optional)

You must have:

1. The probe in the spindle.
2. The Ring Gauge mounted on the machine table.

To calibrate the probe:

1. Jog the probe to the approximate center of the ring gauge by eye and into the hole of the ring gauge at the depth that you wish the probe stylus to come in contact with the inside of the ring gauge hole.
2. From the MDI mode, go to the **F5 (Mill)**, then **F10 (Probe)**, then **F3 (SpinPro)**, then select **Probe Calibration**. Type the appropriate information, press **exit**, and then press **START**.
3. The probe will touch four sides of the inside of the hole. The spindle will rotate (if the machine has spindle orientation) 180 degrees and touch the same four sides again establishing the center of the ring gauge. The spindle will then orient and touch four sides one more time calibrating the probe.
4. Remove the ring gauge from the machine and you are now ready to start spindle probing.

**NOTE:** On machines that allow the spindle probe to be installed in the spindle with more than one orientation, the probe stylus must be indicated true to the spindle centerline or the probe will not be accurate once removed and replaced into the spindle again.



### Edge Finding (EdgeFind)

**Format:** EdgeFind SearchDir(XPlus, XMinus, YPlus, YMinus, ZPlus, or ZMinus) Offset(0–9)

- ❑ Calibrate the work probe at least once before trying to use this cycle.
- ❑ A preliminary tool-length offset must be set by eye for the work probe and that tool offset active before using this cycle in a program. See the operations manual for setting and activating tool-length offsets.
- ❑ A preliminary work offset must be set by eye and that work coordinate active before using this cycle in a program. See the operations manual for setting and activating work coordinate offsets.
- ❑ The EdgeFind Edge Finding Cycle can be run from within a program or from the MDI mode. Refer to **Table 4-12**.

**Table 4-12, EdgeFind Entry Fields**

Entry Fields	Description
<b>SearchDir</b>	Axis and direction to find edge. <b>XPlus, XMinus, YPlus, YMinus, ZPlus, or ZMinus</b> (Required)
<b>Offset</b>	Work Coordinate to update with edge location in X- or Y-axes. If set, work coordinate will be updated if <b>XPlus, XMinus, YPlus, and YMinus</b> are specified for <b>SearchDir</b> , or tool-length offset will be set for the current tool number if <b>SearchDir</b> is set to <b>ZPlus, or ZMinus</b> . <b>NOTE:</b> Before any tool-length offset is active, you must recall that tool. Work coordinate register or Tool-length register will not be updated if <b>Offset</b> is not set and a warning message will tell the operator no update has taken place. [Default: <b>0</b> ] Range (0–9) (Optional)

To use the Edge Finding Cycle:

1. Place the probe in the spindle.
2. Manually jog the probe stylus less than 0.1" (2.54 mm) away from the surface to be found.
3. Input EdgeFind SearchDir(?) Offset(n). If this is run from inside a program, this line needs to be repeated for every surface you wish to find.

**Caution:** When positioning the probe from within the program you should always use the **ProbeMove** cycle. Refer to "[Protected Probe Positioning \(ProbeMove\)](#)."

4. Execute that line in MDI by exiting and pressing **START**.

**Outside Corner Finding (CornerOut)**

**Format:** CornerOut SearchQuad(XPlusYPlus, XMinusYPlus, XMinusYMinus, XPlusYMinus) Top(Yes/NO) DistDown(n) DistSide(n) DistBack(n) DistInX(n) DistInY(n) X(n) Y(n) Z(n) Offset (0–9))

- ❑ Calibrate the work probe at least once before trying to use this cycle.
- ❑ A preliminary tool-length offset must be set by eye for the work probe and that tool offset must be active before using this cycle in a program. See the operations manual for setting and activating tool-length offsets.
- ❑ A preliminary work offset must be set by eye and that work coordinate active before using this cycle in a program. See the operations manual for setting and activating work coordinate offsets.
- ❑ The CornerOut Outside Corner Finding Cycle can be run from within a program or from the MDI mode. Refer to **Table 4-13**.

**Table 4-13, CornerOut Entry Fields**

Entry Fields	Description
<b>SearchQuad</b>	Quadrant of corner to find. <b>XPlusYPlus</b> = +,+ (upper right) <b>XMinusYPlus</b> = -,+ (upper left) <b>XMinusYMinus</b> = -,- (lower left) <b>XPlusYMinus</b> = +,- (lower right) (Required)
<b>Top</b>	If set to <b>Yes</b> , the cycle will find the top of the part before finding the X & Y corner coordinate. Default is <b>No</b> . If <b>Top</b> is not set or is set to <b>No</b> , the Z-axis must be at the picking depth. If <b>Top</b> = <b>Yes</b> , then the Z-axis must be within 0.1" (2.54 mm) above the part. The probe stylus must be positioned within 0.1" (2.54 mm) from the outside of the corner in X & Y. (Optional)
<b>DistDown</b>	The distance to go down from the top of part to find X & Y coordinate of the corner. This is only used if <b>Top</b> parameter is set to <b>Yes</b> . Without any <b>DistDown</b> value, the cycle will bring the probe stylus center down past the top of the part after finding the top, 0.1" (2.54 mm). (Optional)
<b>DistSide</b>	The distance over from the corner to find X & Y edge. This will allow for a part corner that has a large chamfer or radius where you cannot pick the edge close to the theoretical corner or has an obstruction interfering with the default move. Default is 0.4" (10.16 mm). (Optional)

(Continued...)

**Table 4-13, CornerOut Entry Fields (Continued)**

Entry Fields	Description
<b>DistBack</b>	Specifies the distance away from the edge for the probe to fast feed to before trying to find it. Default is, 0.1" (2.54 mm) if not set. (Optional)
<b>DistInX</b>	The distance from the starting point to move in the X-axis to find the top of the part. The default is toward the corner being found 0.4" (10.16 mm). (Optional)
<b>DistInY</b>	The distance from the starting point to move in the Y-axis to find the top of the part. The default is toward the corner being found 0.4" (10.16 mm). (Optional)
<b>X</b>	This causes the cycle to make a protected X move to the coordinate entered relative to the current active work coordinate before finding the corner. (Optional)
<b>Y</b>	Same as <b>X</b> only for the Y-axis. (Optional)
<b>Z</b>	Same as <b>X</b> only for the Z-axis. (Optional)
<b>Offset</b>	Work Coordinate to update with edge location in X- and Y-axes. If set, work coordinate will be updated. Work coordinate register will not be updated if not set and a warning message will tell the operator no update has taken place if <b>Offset</b> is not set. [Default: <b>0</b> ] Range (0–9) (Optional)

To use the Outside Corner Finding Cycle:

1. Place the probe in the spindle.
2. Manually jog the probe stylus less than 0.1" (2.54 mm) away from the outside of the corner you wish to find in X & Y. If **Top = Yes**, the Z-axis should be within 0.1" (2.54 mm) above the part otherwise the Z-axis should be at the side picking depth.
3. Input CornerOut SearchQuad(XPlusYPlus) Offset(n)  
If this is run from inside a program, this line needs to be repeated for every corner you wish to find or whose position you want to reestablish.

**Caution:** When positioning the probe from within the program you should always use the **ProbeMove (Protected Probe Positioning)** cycle (refer to "[Protected Probe Positioning \(ProbeMove\)](#)") or use the **X, Y, or Z** parameters for the same purpose.

4. Execute that line in MDI by exiting and pressing **START**.

**Inside Corner Finding (CornerIn)**

**Format:** CornerIn SearchQuad(XPlusYPlus, XMinusYPlus, XMinusYMinus, XPlusYMinus) Top(Yes/No) DistDown(n) DistSide(n) DistBack(n) DistInX(n) DistInY(n) X(n) Y(n) Z(n) Offset(0-9)

- ❑ Calibrate the work probe at least once before trying to use this cycle.
- ❑ A preliminary tool-length offset must be set by eye for the work probe and that tool offset active before using this cycle in a program. See the operations manual for setting and activating tool-length offsets.
- ❑ A preliminary work offset must be set by eye and that work coordinate active before using this cycle in a program. See the operations manual for setting and activating work coordinate offsets.
- ❑ The CornerIn Inside Corner Finding Cycle can be run from within a program or from the MDI mode. Refer to **Table 4-14**.

**Table 4-14, CornerIn Entry Fields**

Entry Fields	Description
<b>SearchQuad</b>	Quadrant of corner to find. <b>XPlusYPlus</b> = +,+ (upper right) <b>XMinusYPlus</b> = -,+ (upper left) <b>XMinusYMinus</b> = -,- (lower left) <b>XPlusYMinus</b> = +,- (lower right) (Required)
<b>Top</b>	If set to <b>Yes</b> , the cycle will find the top of the part before finding the X & Y corner coordinate. Default is <b>No</b> . If <b>Top</b> is not set or is set to <b>No</b> , the Z-axis must be at the picking depth. If <b>Top = Yes</b> , then the Z-axis must be within 0.1" (2.54 mm) above the part. The probe stylus must be positioned within 0.1" (2.54 mm) from the outside of the corner in X & Y. (Optional)
<b>DistDown</b>	The distance to go down from the top of part to find X & Y coordinate of the corner. This is only used if <b>Top</b> parameter is set to <b>Yes</b> . Without any <b>DistDown</b> value, the cycle will bring the probe stylus center down past the top of the part after finding the top, 0.1" (2.54 mm). (Optional)
<b>DistSide</b>	The distance over from the corner to find X & Y edge. This will allow for a part corner that has a large chamfer or radius where you cannot pick the edge close to the theoretical corner or has an obstruction interfering with the default move. Default is 0.4" (10.16 mm). (Optional)

(Continued...)

**Table 4-14, CornerIn Entry Fields (Continued)**

Entry Fields	Description
<b>DistBack</b>	Specifies the distance away from the edge for the probe to fast feed to before trying to find it. Default is, 0.1" (2.54 mm) if not set. (Optional)
<b>DistInX</b>	The distance from the starting point to move in the "X" axis to find the top of the part. The default is toward the corner being found 0.4" (10.16 mm). (Optional)
<b>DistInY</b>	The distance from the starting point to move in the "Y" axis to find the top of the part. The default is toward the corner being found 0.4" (10.16 mm). (Optional)
<b>X</b>	This causes the cycle to make a protected X move to the coordinate entered relative to the current active work coordinate before finding the corner. (Optional)
<b>Y</b>	Same as <b>X</b> only for the Y-axis. (Optional)
<b>Z</b>	Same as <b>X</b> only for the Z-axis. (Optional)
<b>Offset</b>	Work Coordinate to update with edge location in X- and Y-axes. If set, work coordinate will be updated. Work coordinate register will not be updated if not set and a warning message will tell the operator no update has taken place if <b>Offset</b> is not set. [Default: <b>0</b> ] Range (0–9) (Optional)

To use the Inside Corner Finding Cycle:

1. Place the probe in the spindle.
2. Manually jog the probe stylus less than 0.1" (2.54 mm) away from the outside of the corner you wish to find in X & Y. If **Top = Yes**, the Z-axis should be within 0.1" (2.54 mm) above the part; otherwise, the Z-axis should be at the side picking depth.
3. Input CornerIn SearchQuad(XPlusYPlus) Offset(0–9)  
If this is run from inside a program, this line needs to be repeated for every corner you wish to find or whose position you want to reestablish.

**Caution:** When positioning the probe from within the program you should always use the **ProbeMove (Protected Probe Positioning)** cycle (see "[Protected Probe Positioning \(ProbeMove\)](#)") or use the **X**, **Y**, or **Z** parameters for the same purpose.

4. Execute that line in MDI by exiting and pressing **START**.

**Inside/Outside Boss/Hole Finding (InOutBoss)**

**Format:** InOutBoss Side(In/Out) Length(n) Width(n) Top(Yes/No)  
 DistDown(n) DistBack(n) DistInX(n) DistInY(n) X(n) Y(n) Z(n) Offset(0–9)  
 RepeatMeas(Yes/No)

- ❑ Calibrate the work probe at least once before trying to use this cycle.
- ❑ A preliminary tool-length offset must be set by eye for the work probe and that tool offset active before using this cycle in a program. See the operations manual for setting and activating tool-length offsets.
- ❑ A preliminary work offset must be set by eye and that work coordinate active before using this cycle in a program. See the operations manual for setting and activating work coordinate offsets.
- ❑ The InOutBoss Inside or Outside Boss/Hole Finding Cycle can be run from within a program or from the MDI mode. Refer to **Table 4-15**.

**Table 4-15, InOutBoss Entry Fields**

Entry Fields	Description
<b>Side</b>	Inside or Outside. <b>In</b> = Inside Hole <b>Out</b> = Outside Boss (Required)
<b>Length</b>	Estimated length in the X-axis of boss/hole if rectangular or the Diameter if round. (Required)
<b>Width</b>	Estimated width in the Y-axis of boss/hole. <b>Width</b> is only specified if boss or hole is rectangular in shape. (Optional)
<b>Top</b>	If set to “Yes” the cycle will find the top of the part before finding center of hole or boss. If <b>Side</b> parameter is set to <b>Out</b> , <b>Top</b> is forced to <b>Yes</b> as well; otherwise, the default is <b>No</b> . (Optional)
<b>DistDown</b>	The distance to go down from the top of part to find X & Y coordinate of the center. This is only used if <b>Top</b> parameter is set to <b>Yes</b> . Without any <b>DistDown</b> value, the cycle will bring the probe stylus center down past the top of the part after finding the top, 0.1” (2.54 mm). (Optional)
<b>DistBack</b>	Specifies the distance away from the edge for the probe to fast feed to before trying to find it. Default is, 0.1” (2.54 mm) if not set. (Optional)

*(Continued...)*

**Table 4-15, InOutBoss Entry Fields (Continued)**

Entry Fields	Description
<b>DistInX</b>	The distance from the starting point to move in the X-axis to find the top of the part. The default, if <b>Side</b> is not set or set to <b>In</b> , is 0.1" beyond the edge of the boss/hole. If <b>Side</b> is set to <b>Out</b> , the default is the current probe position. (Optional)
<b>DistInY</b>	The distance from the starting point to move in the Y-axis to find the top of the part. The default is the current probe position. (Optional)
<b>X</b>	This causes the cycle to make a protected X move to the coordinate entered relative to the current active work coordinate before finding the boss/hole center. (Optional)
<b>Y</b>	Same as <b>X</b> only for the Y-axis. (Optional)
<b>Z</b>	Same as <b>X</b> only for the Z-axis. (Optional)
<b>Offset</b>	Work Coordinate to update with the center location in X- and Y-axes. If set, work coordinate will be updated. Work coordinate register will not be updated if not set and a warning message will tell the operator no update has taken place if <b>Offset</b> is not set. [Default: <b>0</b> ] Range (0–9) (Optional)
<b>RepeatMeas</b>	If set to <b>Yes</b> , the cycle will do a preliminary measure in the "X" axis to get on center before measuring the Y-axis, making a total of 6 touches. If set to <b>No</b> , the cycle will only measure "X" once for a total of 4 touches. Default is <b>No</b> . (Optional)

To use the Inside/Outside Boss/Hole Finding Cycle:

1. Place the probe in the spindle.
2. Manually jog the probe stylus the approximate center in X & Y within 0.1" (2.54 mm). If **Top = Yes**, the Z-axis should be within 0.1" (2.54 mm) above the part otherwise the Z-axis should be at the side picking depth.
3. Input InOutBoss Side(In/Out) Length(n) Width(n) Offset(0–9)  
If this is run from inside a program, this line needs to be repeated for every boss/hole you wish to find or whose position you want to reestablish.

**Caution:** When positioning the probe from within the program, you should always use the **ProbeMove (Protected Probe Positioning)** cycle (see "[Protected Probe Positioning \(ProbeMove\)](#)") or use the **X, Y, or Z** parameters for the same purpose.

4. Execute that line in MDI by exiting and pressing **START**.

**Inside/Outside Web Finding (InOutWeb)**

**Format:** InOutWeb Side(In/Out) Length(n) Width(n) Top(Yes/No)  
 DistDown(n) DistBack(n) DistInX(n) DistInY(n) X(n) Y(n) Z(n) Offset(0–9)

- ❑ An inside Web is a slot. An outside Web is a standing rib.
- ❑ Webs can only be measured in the X- or Y-axis.
- ❑ Calibrate the work probe at least once before trying to use this cycle.
- ❑ A preliminary tool-length offset must be set by eye for the work probe and that tool offset active before using this cycle in a program. See the operations manual for setting and activating tool-length offsets.
- ❑ A preliminary work offset must be set by eye and that work coordinate active before using this cycle in a program. See the operations manual for setting and activating work coordinate offsets.
- ❑ The InOutWeb Inside or Outside Web Finding Cycle can be run from within a program or from the MDI mode. Refer to **Table 4-16**.

**Table 4-16, InOutWeb Entry Fields**

Entry Fields	Description
<b>Side</b>	Inside or Outside. <b>In</b> = Inside Hole <b>Out</b> = Outside Boss (Required)
<b>Length</b>	Estimated X width of Web if measuring in the X-axis. <b>Length</b> or <b>Width</b> must be specified but only one, not both.
<b>Width</b>	Estimated Y width of Web if measuring in the Y-axis. <b>Length</b> or <b>Width</b> must be specified but only one, not both.
<b>Top</b>	If set to <b>Yes</b> , the cycle will find the top of the part before finding center of Web. If <b>Side</b> parameter is set to <b>Out</b> , <b>Top</b> is forced to <b>Yes</b> as well; otherwise, the default is <b>No</b> . (Optional)
<b>DistDown</b>	The distance to go down from the top of part to find X or Y coordinate of the center. This is only used if <b>Top</b> parameter is set to <b>Yes</b> . Without any <b>DistDown</b> value, the cycle will bring the probe stylus center down past the top of the part after finding the top, 0.1" (2.54 mm). (Optional)
<b>DistBack</b>	Specifies the distance away from the edge for the probe to fast feed to before trying to find it. Default is 0.1" (2.54 mm), if not set. (Optional)

*(Continued...)*



**Table 4-16, InOutWeb Entry Fields (Continued)**

Entry Fields	Description
<b>DistInX</b>	The distance from the starting point to move in the X-axis to find the top of the part. The default, if <b>Side</b> is not set or set to <b>In</b> , is 0.1" beyond the edge of the web. If <b>Side</b> is set to <b>Out</b> , the default is the current probe position. (Optional)
<b>DistInY</b>	The distance from the starting point to move in the Y-axis to find the top of the part. The default is the current probe position. (Optional)
<b>X</b>	This causes the cycle to make a protected X move to the coordinate entered relative to the current active work coordinate before finding the web center. (Optional)
<b>Y</b>	Same as <b>X</b> only for the Y-axis. (Optional)
<b>Z</b>	Same as <b>X</b> only for the Z-axis. (Optional)
<b>Offset</b>	Work Coordinate to update with the center location in X- or Y-axes. If set, work coordinate will be updated. Work coordinate register will not be updated if not set and a warning message will tell the operator no update has taken place if <b>Offset</b> is not set. [Default: <b>0</b> ] Range (0–9) (Optional)

To use the Inside/Outside Web Finding Cycle:

1. Place the probe in the spindle.
2. Manually jog the probe stylus the approximate center in X or Y within 0.1" (2.54 mm). If **Top = Yes**, the Z-axis should be within 0.1" (2.54 mm) above the part otherwise the Z-axis should be at the side picking depth.
3. Input InOutWeb Side(In/Out) Length(n) Offset(0–9)  
If this is run from inside a program, this line needs to be repeated for every web you wish to find or whose position you want to reestablish.

**Caution:** When positioning the probe from within the program you should always use the **ProbeMove (Protected Probe Positioning)** cycle (see "[Protected Probe Positioning \(ProbeMove\)](#)") or use the **X, Y, or Z** parameters for the same purpose.

4. Execute that line in MDI by exiting and pressing **START**.

**Protected Probe Positioning (ProbeMove)**

**Format:** ProbeMove X(n) Y(n) Z(n) Feed(n)

- ❑ When an X, Y, and/or Z move is programmed using the **ProbeMove** (Protected Positioning Cycle), the control will stop and alarm if the probe stylus is triggered before reaching the target set in the X, Y, and/or Z parameters.
- ❑ This cycle is intended to offer some degree of safety when moving the probe around the part; however, it is not fool proof and will not protect against gross bad programming where the probe body would encounter an obstruction before the probe stylus is triggered. Extreme care should be taken to avoid this condition as probe damage may result.
- ❑ Calibrate the work probe at least once before trying to use this cycle.
- ❑ A preliminary tool-length offset must be set by eye for the work probe and that tool offset active before using this cycle. See the operations manual for setting and activating tool-length offsets.
- ❑ A preliminary work offset must be set by eye and that work coordinate active before using this cycle. See the operations manual for setting and activating work coordinate offsets.
- ❑ The ProbeMove Protected Probe Positioning Cycle can be run from within a program or from the MDI mode. Refer to **Table 4-17**.

**Table 4-17, ProbeMove Entry Fields**

Entry Fields	Description
<b>X</b>	X Target position relative to current active work coordinate.
<b>Y</b>	Y Target position relative to current active work coordinate.
<b>Z</b>	Z Target position relative to current active work coordinate combined with the current active tool-length offset.
<b>Feed</b>	Feedrate at which to travel to target. <b>Feed</b> is only active for the current move so it must be restated every time or the default will take precedence. The default is set in the machine setup parameter " <b>Positioning feedrate normally</b> ". (Optional)

To use the ProbeMove Protected Probe Positioning Cycle:

1. Place the probe in the spindle and make sure that its tool and work coordinate offsets are active.
2. Input  
 ProbeMove X(n) Y(n) Z(n) Feed(n)  
 If this is run from inside a program, this line needs to be repeated for every move you wish to make.
3. Execute that line in MDI by exiting and pressing **START**.

**Skew Error Find (SkewComp)**

**Format:** SkewComp Action(Find/FindActive/Activate) EstAngle(n)  
DistPicks(n) Top(Yes/No) DistDown(n) DistBack(n) DistInX(n) DistInY(n)  
X(n) Y(n) Z(n)

- ❑ RMS cannot be used with **SkewComp**, skew error find.
- ❑ Skew error is only supported for along the side edge of a part relative to the X,Y plane.
- ❑ Calibrate the work probe at least once before trying to use this cycle.
- ❑ A preliminary tool-length offset must be set by eye for the work probe and that tool offset active before using this cycle in a program. See the operations manual for setting and activating tool-length offsets.
- ❑ A preliminary work offset must be set by eye and that work coordinate active before using this cycle in a program. See the operations manual for setting and activating work coordinate offsets.
- ❑ The probe must be pre-positioned to the proper spot in relation to the part in accordance with the specified **EstAngle** cycle parameter as described below or an X, Y, and/or Z should be included for pre-positioning.
- ❑ The SkewComp Skew Error Finding Cycle can be run from within a program or from the MDI mode. Refer to [Table 4-18, SkewComp Entry Fields](#).

**Table 4-18, SkewComp Entry Fields**

Entry Fields	Description
<p><b>Action</b></p>	<p><b>Find</b> Finds the skew angle, but does not activate skew compensation.  <b>FindActive</b> Finds the skew angle, and activates skew compensation.  <b>Activate</b> Activates skew compensation with the current skew value, but will not rerun the cycle on the part.                      [Default: <b>Find</b>]</p> <p><b>NOTE:</b> If <b>Activate</b> is used, all other <b>SkewComp</b> parameters are ignored.</p> <p><b>NOTE:</b> Before using <b>SkewComp Activate</b>, you must have called <b>SkewComp</b> at least once with <b>Find</b> or <b>FindActive</b>, or the error message "Skew error has not been found!" is displayed.</p> <p>Skew compensation will be activated around the current active work coordinate and will only work from within the program being run. Skew compensation cannot be activated directly or indirectly using <b>SkewComp</b> from the MDI mode. The operator can run the <b>SkewComp</b> from MDI but must place <b>SkewComp Activate</b> inside the program for skew compensation to take effect. An <b>Offset</b> work coordinate call will deactivate skew compensation, necessitating a re-issuance of <b>SkewComp Activate</b> to activate skew compensation. Using <b>FindActive</b> or <b>Activate</b> will default the control to Absolute. If you are in Incremental, you will need to switch back after the cycle has been run. (Optional)</p>
<p><b>EstAngle</b></p>	<p>Estimated amount of angle from 3 O'clock. Default is "0" which will cause the cycle to find the angle of the back edge of the part starting its first pick in the upper-left corner and making the second pick to the left of that, as you are facing the surface being picked. Examples:  <b>EstAngle=90</b>                      Would start in the lower-left side, picking in the X positive direction, finding the skew of the left side of the part.  <b>EstAngle=-90</b>                      Would start in the upper-right side, picking in the X negative direction, finding the skew of the right side of the part.  <b>EstAngle=180</b>                      Would start in the lower-right front edge of the part, picking in the Y positive direction, finding the skew of the front edge of the part.                      [Default: 0] (Optional)</p>
<p><b>DistPicks</b></p>	<p>The distance from the first pick to the second pick. Default is 2.0" (50.8 mm) (Optional)</p>
<p><b>Top</b></p>	<p>If set to <b>Yes</b>, the cycle will find the top of the part before finding part skew angle. Default is <b>No</b>. If <b>Top</b> is set to <b>Yes</b>, the probe stylus should be pre-positioned within 0.1" (2.54 mm) above the part. If <b>Top</b> is set to <b>No</b>, the probe stylus should be positioned at the Z-axis depth from which you want to make side picks. (Optional)</p>

**Table 4-18, SkewComp Entry Fields (Continued)**

Entry Fields	Description
<b>DistDown</b>	The distance to go down from the top of part to find part skew angle. This is only used if <b>Top</b> parameter is set to <b>Yes</b> . Without any <b>DistSide</b> value, the cycle will bring the probe stylus center down past the top of the part after finding the top, 0.1" (2.54 mm). (Optional)
<b>DistBack</b>	<p>Specifies the distance away from the edge for the probe to fast feed to before trying to find it. Default is, 0.1" (2.54 mm) if not set. This would be used to make sure that the cycle is picking from far enough away from the edge so that it will not trigger the probe prematurely when stepping over to make the second pick.</p> <p><b>Hint:</b> If the <b>EstAngle</b> parameter is relatively accurate, this parameter will not be needed because the default will be good enough.</p> <p>(Optional)</p>
<b>DistInX</b>	The distance from the starting point to move in the "X" axis to find the top of the part. The default is 1.0" (25.4 mm) toward the part at the angle specified in the <b>EstAngle</b> parameter. (Optional)
<b>DistInY</b>	The distance from the starting point to move in the "Y" axis to find the top of the part. The default is 1.0" (25.4 mm) toward the part at the angle specified in the <b>EstAngle</b> parameter. (Optional)
<b>X</b>	This causes the cycle to make a protected X move to the coordinate entered relative to the current active work coordinate before finding the skew angle. (Optional)
<b>Y</b>	Same as <b>X</b> only for the Y-axis. (Optional)
<b>Z</b>	Same as <b>X</b> only for the Z-axis. (Optional)

To use the Skew Error Finding Cycle:

1. Place the probe in the spindle.
2. Manually jog the probe stylus to the appropriate start position relative to the part as specified by the **EstAngle** cycle parameter in **Table 4-18**. X or Y should be within 0.1" (2.54 mm) of the part edge. If **Top = Yes**, the Z-axis should be within 0.1" (2.54 mm) above the part; otherwise, the Z-axis should be at the side picking depth. If run from within a program, probe must be pre-positioned.
3. Input SkewComp Action(Find/FindActive/Activate) EstAngle(n)  
If this is run from inside a program, this line needs to be repeated every time you wish to find a skew angle.

**Caution:** When positioning the probe from within the program you should always use the **ProbeMove (Protected Probe Positioning)** cycle (see "[Protected Probe Positioning \(ProbeMove\)](#)") or use the **X, Y, or Z** parameters for the same purpose.

4. Execute that line in MDI by exiting and pressing **START**.

## Section 5 - Editing Programs

Write and edit conversational program blocks using the CNC's Conversational Program Editor (the Edit screen). Activate the Conversational Program Editor to put the CNC in the Edit Mode.

### Activating the Conversational Program Editor

You can activate the Conversational Program Editor screen either from the Program Directory or from the Manual screen. When you activate the Program Editor from the Program Directory, the highlighted program opens for editing. When you activate the Program Editor from the Manual screen, the selected program opens for editing.

To activate the Program Editor from the Program Directory:

1. In the Program Directory, highlight a program.
2. Press **Edit (F4)**. The Program Editor opens the selected program for editing.

To activate the Program Editor from the Manual screen:

1. In the Manual screen, press **EDIT (F4)**. The Editor opens the loaded program. If no program is loaded, the CNC displays the message **No Program Selected !**.
2. Press **PROGRAM (F2)** to activate the Program Directory.
3. Highlight a program.
4. Press **Edit (F4)**. The Program Editor opens the selected program for editing.

### The Program Editor Screen

The Program Editor monitors mode changes written to a program. The mode indicators displayed in the Program Editor indicate the CNC's active modes. Refer to **Figure 5-1**.

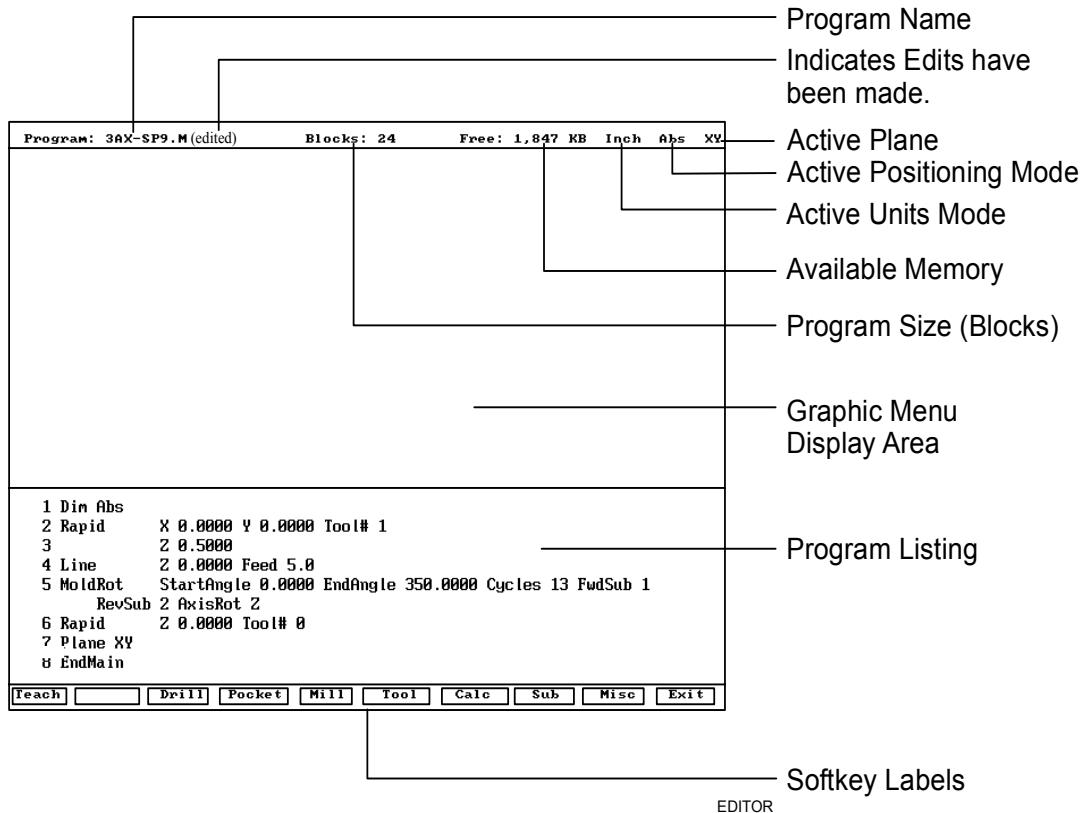

**Figure 5-1, Program Editor**

<b>Program Name</b>	Name of the program opened for editing.
<b>(edited) Marker</b>	Indicates that you have edited the program, but the edits have not been saved.
<b>Active Plane</b>	Current operating plane ( <b>XY</b> , <b>XZ</b> , <b>YZ</b> ).
<b>Active Positioning Mode</b>	Current measurement mode ( <b>Abs/Inc</b> ).
<b>Active Units Mode</b>	Current units mode ( <b>Inch/MM</b> ).
<b>Available Memory</b>	Amount of room remaining in the Editor's memory.
<b>Program Size</b>	Number of blocks in the program.
<b>Graphic Menu Area</b>	Area for displaying the Graphic Menus.



<b>Program Listing</b>	Current listing of the blocks in the open program.
<b>Highlight</b>	Selects a block for editing and acts as an insertion marker for adding new blocks. The CNC tracks program mode changes up to this point in the Program Listing.
<b>Softkey Labels</b>	<p>These labels define the soft key functions. The following sets of soft keys are available.</p> <ul style="list-style-type: none"> <li>❑ Default set, normally visible.</li> <li>❑ Misc soft keys, activated by pressing <b>Misc (F9)</b>.</li> <li>❑ Sub soft keys, activated by pressing <b>Sub (F8)</b>.</li> </ul>

## Saving Edits

The Program Listing displays text entered by the programmer. The CNC does not save edits until you exit the Editor. If the **(edited)** marker is visible at the top of the Program Editor, the open program contains unsaved edits.

To save edits:

1. In Edit Mode, press **Exit (F10)**. The CNC saves all edits and returns to the Program Directory.

## Canceling Unsaved Edits

To cancel unsaved edits:

1. In Edit Mode, press **Misc (F9)**. Misc soft key labels are displayed.
2. Press **Quit (F8)**. The CNC displays the message **WARNING: Program has been edited. Sure you want to QUIT?** and changes the soft key labels.
3. Press **Yes (F1)**. The CNC returns to the Program Directory without saving the edits. Press **No (F2)** to cancel.

## Deleting a Block

To delete a program block:

1. In Edit Mode, highlight a block.
2. Press **CLEAR**.

### Inserting a Block

To insert a program block:

1. In Edit Mode, highlight the block that will follow the inserted block.
2. Program the new block from the appropriate Graphic Menu. When you save the new block, it appears in front of the highlighted block. Blocks are automatically renumbered.

### Editing Blocks

To edit a program block:

1. In Edit Mode, highlight a block.
2. Press **ENTER** if the existing block is a move or cycle. The appropriate Graphic Menu opens.
3. Highlight the entry fields that require changes. Press **CLEAR** to erase the existing values.
4. Make the appropriate changes. Press **Save (F10)** to close the block.

<p><b>NOTE:</b> When the program block's Graphic Menu offers two modes (for example, Cw/Ccw), highlight the block and press <b>+/-</b> to change the selection.</p>
---

### Searching Blocks for Words or Numbers

Use **Search** to find a block number or word. **Search** looks only from the cursor position forward. To search an entire program, place the cursor at the beginning of the program, then activate **Search**.

To search for a block number or word:

1. In Edit Mode, Press **Misc (F9)**. The soft key menu changes.
2. Press **Search (F3)**. The CNC prompts for the block number or word.
3. Use the ASCII chart to type the block number or word. (You can also use the keypad to type numbers.)
4. Press **ENTER**. The CNC searches and highlights the next block that contains the specified word or block number.

### Scrolling the Program Listing

In Edit Mode, use the up and down **ARROWS** to scroll through the Program Listing.

### Paging through the Program Listing

To scroll through the Program Listing one page at a time:

1. In Edit Mode, Press **Misc (F9)**. The CNC displays the Soft key secondary functions.
2. Press the **PgUp (F4)** or **PgDn (F5)** keys to page forward or backward.
3. Press **Prev (F9)**. The CNC redisplay the Program Editor default soft keys.

### Jumping to First or Last Block in the Program

To jump to the first or last block of the Program Listing:

1. In Edit Mode, press **Misc. (F9)**. The CNC displays the Soft key secondary functions.
2. Press **Begin (F6)**. The Program Listing displays the first block of the program.

– or –

Press **End (F7)**. The Program Listing displays last block of the program.

### Using Comments

The CNC will ignore comment blocks. You can add a new comment block to a program or convert an existing block into a comment. Comment blocks typically contain program setup or tool information, or are used to comment out existing blocks.

### Writing a Comment Block

To write a comment block:

1. In Edit Mode, press **Misc. (F9)**. The CNC displays the Soft key secondary functions.
2. Press **Comment (F2)**. The CNC prompts for a comment.
3. Use your keyboard to type comments.

### Commenting Out Existing Blocks

To comment out an existing block:

1. In Edit Mode, highlight the block being commented out.
2. Press **0** on the keypad. The CNC displays an asterisk after the block number.

<b>NOTE:</b> Offline keyboard users, use the <b>0</b> key (not the asterisk key) to produce a comment block.
--

### Canceling a Comment

To cancel a comment:

1. In Edit Mode, highlight the comment block to be canceled.
2. Press **0**. The CNC deletes the asterisk and will no longer ignore the block during program execution.

**NOTE:** Offline keyboard users, use the **0** key to switch the asterisk on or off.

### Using Block Operations to Edit a Program

In conversational editor, use the **Misc (F9) – More (F1)** soft key to display the More pop-up menu. See **Table 5-1** for a description of the features. See [Figure 5-2, More Pop-up Menu](#). To display the More pop-up menu:

1. In the conversational editor, select **Misc (F9)**.
2. Press **F1 (More)** to display the More pop-up menu.

**Table 5-1, More Pop-up Menu**

Feature	Hot Key	Description
<b>Mark</b>	<b>'M'</b>	Allows program blocks to be marked for a subsequent Cut, Copy, or Delete operation. Selecting Mark again turns off marking.
<b>Copy</b>	<b>'C'</b>	Copies marked blocks into scrap buffer for a subsequent Paste operation. Marking is turned off. Selecting Copy with no blocks marked copies the current block into the scrap buffer.
<b>Paste</b>	<b>'P'</b>	Paste contents of scrap buffer in current location (i.e., above current block).
<b>Cut</b>	<b>'V'</b>	Copies marked blocks into scrap buffer and deletes them. Marking is turned off. Selecting Cut with no blocks marked cuts the current block into the scrap buffer.
<b>Delete</b>	<b>CLEAR</b>	Deletes marked blocks.
<b>Open Program</b>	<b>'O'</b>	Allows the user to open another program for editing without leaving the editor. The scrap buffer is preserved which allows blocks to be copied or moved from one program to another program.

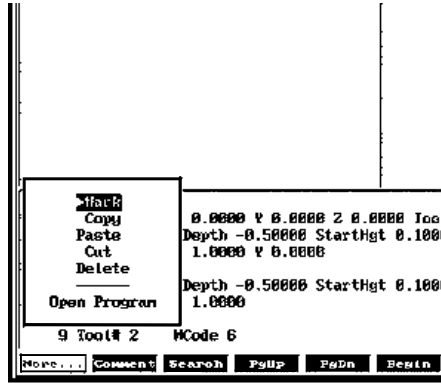

Figure 5-2, More Pop-up Menu

## Section 6 - Calculators

### CNC Calculator Package

The CNC features a powerful calculator package that contains three separate calculators:

- [Mathematics Calculator](#)
- [Right Triangle Calculator](#)
- [Geometry Calculator](#)

You can recall calculator solutions directly into the labeled fields of a Graphic Menu. All three calculators have separate memory space for storing and recalling solutions.

### Math Calculator

The math calculator performs all of the operations commonly offered in a scientific calculator. These include basic math, trigonometry, unit conversion, logs, exponential operations, angle/radian conversions, and finding the inverse.

To activate the Math Calculator:

1. In Edit Mode, press **Calc (F7)** to display the **Select Type of Calculator:** pop-up menu. Refer to **Figure 6-1**.

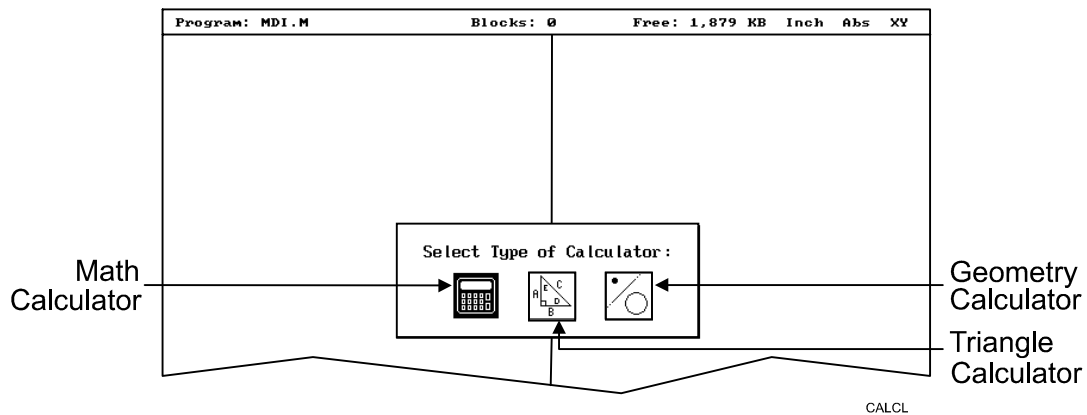

**Figure 6-1, Select Type of Calculator: Pop-up Menu**

- Highlight the **Math Calculator** template and press **ENTER** to display the math calculator pop-up window. Refer to **Figure 6-2**.

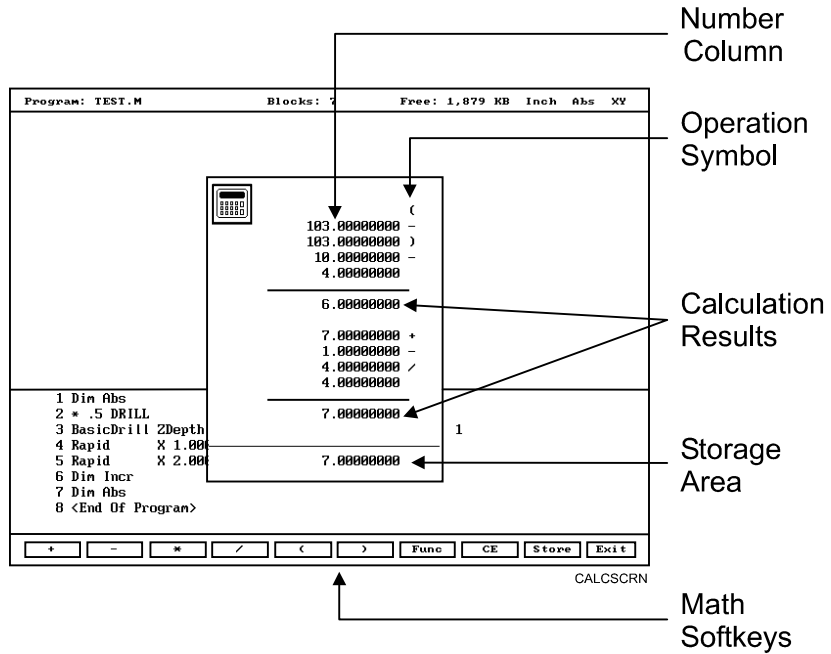

**Figure 6-2, Math Calculator and Soft Keys**

### Math Calculator Basics

The CNC displays numbers in the storage area, as typed. Select the math operation using the appropriate soft key. Refer to **Table 6-1**.

**Table 6-1, Math Operation Soft Keys**

Operation	Soft Key Label	Soft Key Number
<b>Addition</b>	<b>+</b>	<b>(F1)</b>
<b>Subtraction</b>	<b>-</b>	<b>(F2)</b>
<b>Multiplication</b>	<b>*</b>	<b>(F3)</b>
<b>Division</b>	<b>/</b>	<b>(F4)</b>
<b>Left Hand Parenthesis</b>	<b>(</b>	<b>(F5)</b>
<b>Right Hand Parenthesis</b>	<b>)</b>	<b>(F6)</b>
<b>Misc. Function Pop-up Menu</b>	<b>Func</b>	<b>(F7)</b>
<b>Clear</b>	<b>CE</b>	<b>(F8)</b>
<b>Store Number For Recall</b>	<b>Store</b>	<b>(F9)</b>

**NOTE:** Off-line keyboard users can use the keypad operators.

Type the first number of the calculation, and press an operation soft key. The CNC displays the number in the column. Next, select the desired operation to perform with the next number. Type the second number, and so forth.

After typing the last number of a calculation, press **ENTER** to place the final number in the column and calculate the answer. The CNC displays the result in the storage area. Press **Store (F9)** to copy the result into the calculator's memory.

Press **CE (F8)** to clear previous calculations.

If you type illogical combinations of operations and numbers, the CNC displays an error message or a row of asterisks.

## Operations Involving Two Numbers

To add, subtract, multiply, or divide two numbers:

1. With the math calculator active, type the first number, followed by the appropriate function hot key: **+** (**F1**), **-** (**F2**), **\*** (**F3**), or **/** (**F4**). The CNC adds the number and operation symbol to the column.
2. Type the second number and press **ENTER** to add the second number to the column and display the sum in the storage area.

## Math with a Column of Numbers

The CNC handles a column of numbers requiring multiple operations, such as a continuous equation, in standard mathematical order (multiplication, division, addition, and subtraction). Press **ENTER** to generate the result.

## Using Parentheses

Use parentheses to indicate arithmetical operations in a non-standard order. (Example: finding a sum before using it as a multiplication factor.) The CNC performs operations within parentheses first.

When the CNC encounters parentheses, it solves the operation within the parentheses immediately, and substitutes that value for the parenthetical expression in the column.

Use parentheses in pairs. The parenthetical expression must contain a left parenthesis, **(**, at the beginning of the expression, and a right parenthesis, **)**, at the end of the expression. Otherwise, the CNC will not calculate the result.



The CNC performs operations within parentheses top to bottom, as they appear in the column, with innermost expressions solved first.

For example, the following expression:

$$(7 + 4 + ((6 * 9) - 1)) / 8$$

generates a result of 8.

Order of calculation:

$$6 * 9 = 54$$

$$54 - 1 = 53$$

$$53 + 7 = 60$$

$$60 + 4 = 64$$

$$64 / 8 = 8$$

### Using Additional Functions

The **Func (F7)** key activates a pop-up menu that provides access to additional math functions. These functions perform their listed operations on a single number. Refer to **Table 6-2**.

**Table 6-2, Function Selection Pop-up Listing**

<b>Pop-up Menu Label</b>	<b>Function</b>
<b>Sine</b>	Sine Function
<b>Cosine</b>	Cosine Function
<b>Tangent</b>	Tangent Function
<b>ASine</b>	Arcsine Function
<b>ACosine</b>	Arccosine Function
<b>ATangent</b>	Arctangent Function
<b>SQRT</b>	Square Root Function
<b>SQR</b>	Squaring Function
<b>LN</b>	Natural Log Function
<b>Log</b>	Log Function Base 10
<b>Exp</b>	Exponential Function
<b>ToMetric</b>	Inch to Metric Conversion
<b>ToInch</b>	Metric to Inch Conversion
<b>ToDegs</b>	Radian to Degree Conversion
<b>ToRads</b>	Degree to Radian Conversion
<b>Inverse</b>	Inverse Function

To use an additional function:

1. With the math calculator active, type the number and press **Func (F7)** to display the Function pop-up menu to the right of the calculator.
2. Highlight a function and press **ENTER** to display the Result in the storage area.

### Storing Numbers from the Math Calculator

Press **Store (F9)** to copy the number from the storage area to the calculator's memory. The math calculator's memory stores 64 numbers. You can recall numbers stored in memory directly into a program.

### Right Triangle Calculator

The Right Triangle Calculator solves the angles and sides of a right triangle given: any two sides, any two angles, or an angle and a side. Store any or all of the values in the calculator's memory.

To activate the Right Triangle Calculator:

1. With the CNC in Edit Mode, press **Calc (F7)** to display the Calculator selection menu.
2. Highlight the Triangle Calculator template and press **ENTER** to activate the Triangle Calculator. Refer to **Figure 6-3**.

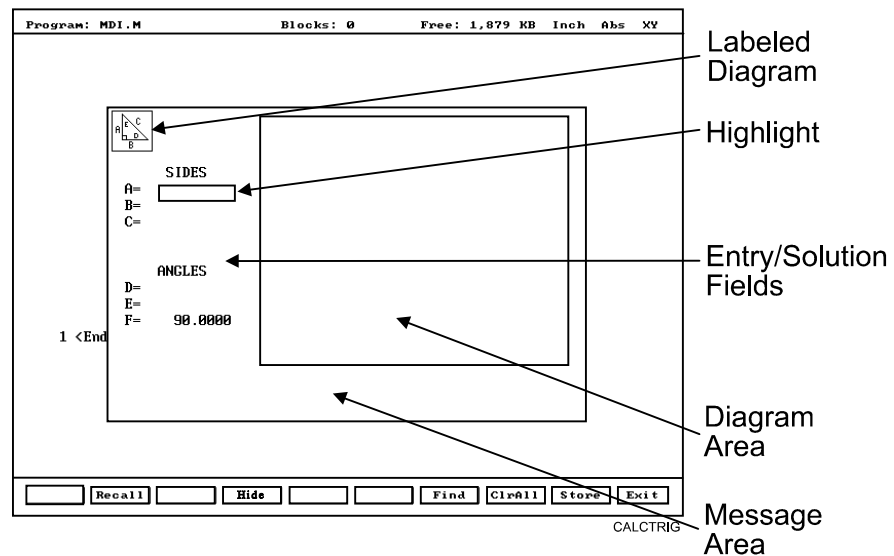

**Figure 6-3, Right Triangle Calculator Screen**

## Using the Triangle Calculator

The Right Triangle Calculator solves only right triangle problems. The Right Triangle Calculator's pop-up screen contains three main areas: the entry/solution area, the diagram area, and the message area.

The labeled entry fields in the entry/solution area correspond to the sides and angles shown in the diagram.

To use the Right Triangle Calculator, type known element values: any two angles, any two sides, or one angle and one side.

After you type two known elements, the CNC calculates and displays values for the remaining sides and/or angles. The CNC places an asterisk after solved element values and displays a scaled drawing of the solved triangle in the diagram area.

To clear a single incorrect value, highlight the value and press **CLEAR**. To clear all displayed values, press **ClrAll (F8)**.

An illogical entry generates an error message.

Recall Right Triangle Calculator solutions directly into a program (for positive (+) incremental moves only). To adjust these solutions to produce absolute coordinates, recall the values into the Math Calculator and add an offset value.

To solve for the sides and angles of a right triangle:

1. With the Right Triangle Calculator active, highlight the field for the first side or angle and type the value.
2. Highlight a second side or angle and type the value.
3. Press **Find (F7)** to display a scaled drawing of the triangle appears in the solution box. The CNC displays calculated sides and angles in unused fields.

## Storing Right Triangle Calculator Results

The CNC will store any side or angle value. Maximum: 64 values.

To store a value:

1. Solve the required triangle.
2. Highlight the value to be stored.
3. Press **ENTER** to store the selected value in memory.

## Hiding the Right Triangle Calculator Screen

To temporarily hide the Right Triangle Calculator Screen:

1. Press **Hide (F4)**. The CNC temporarily hides the Right Triangle Calculator Screen.
2. Press **Find (F7)** to display the screen again.

## Geometry Calculator

The CNC uses Cartesian coordinates (X, Y, Z-axis values) to define most positions. However, you must sometimes determine position coordinates based on the known construction of other elements on the print, including lines, circles, and angles.

The Geometry Calculator provides an assortment of line, circle, angle, and point templates. Use these templates to sketch a geometry construction that identifies the unknown position. The Geometry Calculator inserts a point at the required position. The calculator automatically solves the coordinates of all points. Recall stored coordinates as necessary in a program.

## Activating the Geometry Calculator

To activate the Geometry Calculator:

1. In Edit Mode, press **Calc (F7)** to display the Calculator selection menu.
2. Highlight **Geometry Calculator** template and press **ENTER** to display the Geometry Calculator.

## Geometry Calculator Screen

The Geometry Calculator consists of a pop-up screen with a display area, a message area, and 18 geometry templates. The CNC displays the geometry construction in the display area. Refer to **Figure 6-4**.

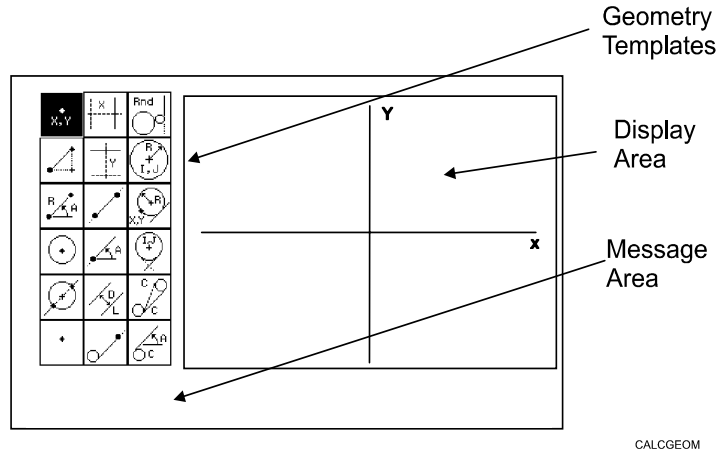

**Figure 6-4, Geometry Calculator**

Use the **DISPLAY (F5)** soft key selections to alter the view of the display area. The **DISPLAY (F5)** options work the same as they do in the Draw Mode display.

The calculator prompts for required values and selections. Type all the appropriate values and selections for the prompts.

## Using the Geometry Calculator

Use the **ARROWS** to select a template. Press **ENTER** to activate the selected tool.

Points, lines, and circles are the basic elements of all sketches. Use the 18 geometry templates to define these elements. Each geometry tool defines an element differently. More than one tool will probably be needed to define the required geometry construction. Templates that require pre-existing points, prompt you to activate one of the point identification templates.

Display-area grid lines appear as solid lines; constructed lines and circles appear as dotted lines; and points are marked with an **x** (lowercase x).

The CNC assigns a number to each element in a sketch. Sketches can contain a maximum of 50 elements.

All elements in the sketch also appear on the Geometry List. The element numbers on the Geometry List correspond to the element numbers in the sketch.

The Geometry List contains the following details about each element:

- Circles** Absolute position of center and radius
- Lines** Orientation (angle) and absolute position at which it crosses X- and/or Y-axis
- Points** Absolute positions

The calculator automatically numbers each element and stores the following details in memory:

- Points** Absolute position
- Circles** Absolute position of center

**NOTE:** The Geometry Calculator does not automatically save the coordinates of an intersection between two elements. Insert a point at the intersection to save its coordinates.

When you delete an element from the sketch, the CNC deletes all stored information regarding that element.

There are three categories of Geometry templates.

- Point templates** Refer to [Table 6-3, Point Templates](#)
- Line templates** Refer to [Table 6-4, Line Templates](#)
- Circle templates** Refer to [Table 6-5, Circle Templates](#)

Review the tables to see the requirements for each template. Many templates require feature(s) of an existing element as a reference. Experiment to become familiar with how each template operates.

**NOTE:** After a series of deletions and additions, the display may appear incomplete. Press **Display (F5)** and select **Redraw** to refresh the screen.

### Point Templates

Some point templates insert points at operator-defined positions. Other point templates use other elements as references. Refer to **Table 6-3**.

Many line and circle templates display a **Select point definition**. . . , message when you activate them. This indicates that the selected tool requires you to select (or create) a reference point.

Templates that insert points at circle centers and element intersections prompt for the required element number(s). The CNC displays all possible intersections; select one.

**Table 6-3, Point Templates**

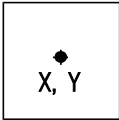
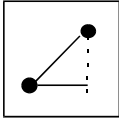
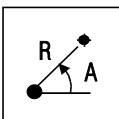
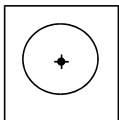
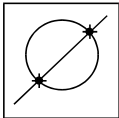
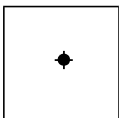
Template	Purpose	Requirements
The following line templates are in the first column of the Calculator screen.		
	Defines a point in a sketch.	Must know the absolute X and Y position of the point.
	Defines a point at an X and Y increment from the existing point.	Must know the incremental X and Y distances from the existing point.
	Defines a point at the radius and angle from the existing point.	Must know the distance from the existing point. Must know the number of degrees and direction (+/-) from the 3 o'clock position.
	Defines a point at the center of an existing circle.	The circle already must be an element of the sketch.
	Defines the point of intersection between two existing elements. Prompts to select which intersection to use when more than one intersection exists.	Sketch must contain two intersecting (or tangential) elements.
	Identifies an existing point. Usually used when the construction of a new element requires a reference point.	Point already must be an element of the sketch.

**Line Templates**

Line templates use other elements or axis positions as references. Templates that draw lines tangent to circles, display all possible tangent lines and prompt you to select one. Refer to **Table 6-4**.

**Table 6-4, Line Templates**

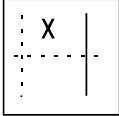
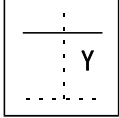
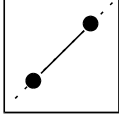
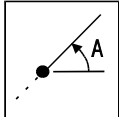
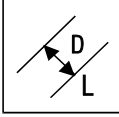
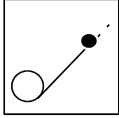
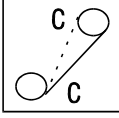
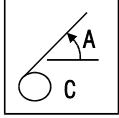
Template	Purpose	Requirements
The following line templates are in the second column of the Calculator screen.		
	Constructs a line parallel to the Y-axis.	Must know the absolute X-axis position of the line.
	Constructs a line parallel to the X-axis.	Must know the absolute Y-axis position of the line.
	Constructs a line between any two points. Prompts you to select a point tool to define each endpoint.	Use any point to locate the two endpoints.
	Constructs a line through a point rotated a specified number of degrees from the 3 o'clock position. Prompts you to select any point tool to define the point of rotation.	Must know the number of degrees and direction (+/-) from the 3 o'clock position. Use any point to locate the point of rotation.
	Constructs a line parallel to the existing line at the specified (positive or negative) distance.	Existing line already must be an element of the sketch.
	Constructs a line through a selected point and tangent to an existing circle. Prompts you to select any point tool for point. Displays tangent lines on both sides of the circle. Select the required tangent.	Circle already must be an element of the sketch. Use any point to locate the point.
The following line templates are in the third column of the Calculator screen.		
	Constructs a line tangent to any two circles. Displays the four possible tangent lines. Select the required tangent.	Two circles already must be elements of the sketch.
	Constructs a line rotated a specified number of degrees from the 3 o'clock position and tangent to the existing circle.	Circle already must be an element of the sketch. Must know the number of degrees of rotation from the 3 o'clock position.



### Circle Templates

Circle templates use other elements as a positioning reference. Templates that draw circles tangent to other circles, lines, or points display all possible tangential circles and prompt you to select one. Refer to **Table 6-5**.

**Table 6-5, Circle Templates**

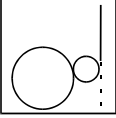
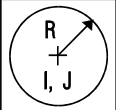
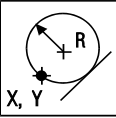
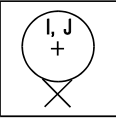
Template	Purpose	Requirements
The following line templates are in the third column of the Calculator screen.		
	Constructs a circle of the specified radius tangent to any two existing elements. All possible tangential circles are displayed. Select the required tangent.	Sketch must contain at least two elements.
	Constructs a circle of the specified radius centered on a position. Prompts you to select a point tool to define the center point.	Use any point to locate the center. Must know the radius.
	Constructs a circle of the specified radius tangent to an existing line and through an existing point. Prompts you to select a point tool to define the point.	Line already must be an element of the sketch. Use any point to locate the point.
	Constructs a circle centered on a point and tangent to an existing line. Prompts you to select any point tool to define the center point.	Line already must be an element of the sketch. Use any point to locate the center.

### Deleting Selected Elements

To delete an element from the sketch:

1. With the Geometry Calculator active, press **GEOMETR (F7)** to display a pop-up menu.
2. Highlight **Delete Item** and press **ENTER**. The CNC prompts for the element number being deleted.
3. Type the element number and press **ENTER** to delete the element.

### Deleting All Elements

To delete all elements from the display area:

1. With the Geometry Calculator active, press **GEOMETR (F7)** to display a pop-up menu.
2. Highlight **Delete All** and press **ENTER**. The CNC prompts to confirm the deletion.
3. Press **Yes (F1)** to delete all elements from the screen.

– or –

Press **No (F2)** to cancel the deletion.

### Listing All Geometry Elements

The CNC stores information on all points, circles, and lines created in the Geometry Calculator in the **Geometry List**. For a point, the CNC lists the X,Y coordinates; for a circle, the circle center and radius; for a line, the endpoint coordinates and sometimes the angle in reference to the 3 o'clock, 0 degree position.

To display the Geometry List:

1. With the Geometry Calculator open, press **GEOMETR (F7)** to display a pop-up menu.
2. Highlight **Geometry List** and press **ENTER** to display the Geometry List.

### Calculating the Distance between Two Elements

Use **Calc. Distance** to calculate the shortest distance between any two elements drawn with the Geometry Calculator.

**NOTE:** For circles, the CNC calculates the shortest distance from the circle center to the other element.

To calculate the distance between two elements in the Geometry Calculator:

1. With the Geometry Calculator open, press **GEOMETR (F7)** to display a pop-up menu.
2. Highlight **Calc. Distance** and press **ENTER**. The CNC prompts, **Enter number of first element:**
3. Type the first element number. The CNC prompts, **Enter number of second element:**
4. Type the second element number to calculate and display the shortest distance between the two elements.

### Last Position Recall

Whenever the calculator prompts for an X position, Y position, or circle, you can recall the last X position, Y position, or circle used by the calculator.

To recall a position:

When the CNC prompts for an X position, Y position, or circle number, press the up and down **ARROWS** to recall the last position, Y position, or circle number used.

## Recalling Values into a Program

The Program Editor always displays **Recall (F2)** when a Graphic Menu activates. Recall calculator solutions stored in memory directly to the entry fields of a Graphic Menu. You can recall stored values only from the same calculator in which they were stored. Use the menu to select the type of recall. Refer to **Figure 6-5**.

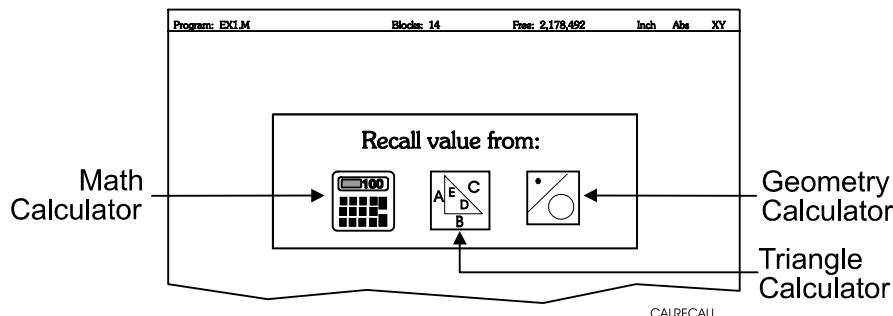
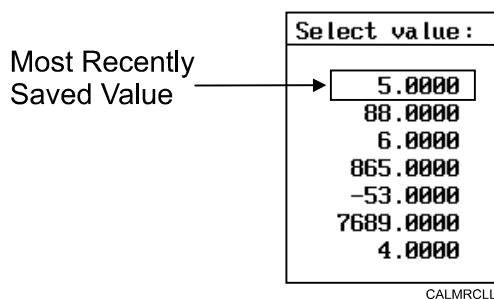

**Figure 6-5, Recall Selection Pop-up Menu**

## Recalling Values from the Math Calculator

To recall a value from the Math Calculator:

1. From the Graphic Menu for the block being edited, highlight the field and press **Recall (F2)** to display the **Recall value from:** pop-up menu.
2. Highlight the **Math Calculator** template and press **ENTER** to display the **Select value:** pop-up menu, with the most recently saved value displayed at the top of the list. Refer to **Figure 6-6**.



**Figure 6-6, Math Calculator Select Value Pop-up Menu**

3. Highlight the required value and press **ENTER** to copy the stored value into the Graphic Menu.

**Recalling Values from the Right Triangle Calculator**

To recall values from the Right Triangle Calculator:

1. From the Graphic Menu for the block being edited, highlight the field receiving the recalled value.
2. Press **Recall (F2)** to display the **Recall value from:** pop-up menu. Refer to **Figure 6-7**.

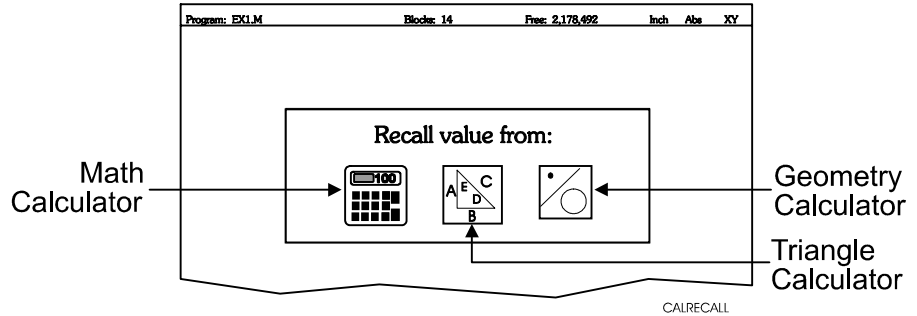

**Figure 6-7, Recall value from: Pop-up Menu**

3. Highlight the **Triangle Calculator** template and press **ENTER** to display the Triangle Calculator **Select value:** pop-up menu. Refer to **Figure 6-8**.

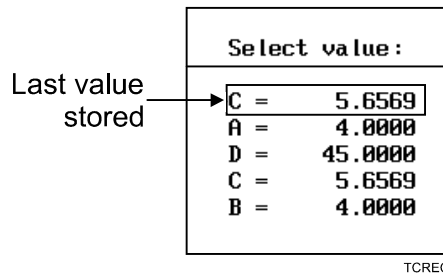

**Figure 6-8, Triangle Calculator Select value: Pop-up Menu**

4. Highlight the required value and press **ENTER** to copy the stored value to the Graphic Menu.

## Recalling Values from the Geometry Calculator

Recall Geometry Calculator values from the calculator's **Select point:** pop-up menu. The CNC displays this menu next to a copy of the sketch that generated the points. The recall list corresponds to the numbered elements on the sketch.

Positions on the recall list followed by a **[C]** are circle centers.

Positions on the recall list followed by a **[P]** are points.

Either one or both of the position coordinates can be recalled.

To recall a value from the Geometry Calculator:

1. From the Graphic Menu for the block being edited, highlight the field receiving the recalled value.
2. Press **Recall (F2)** to display the **Select point:** menu. Refer to [Figure 6-5, Recall Selection Pop-up](#).
3. Highlight the **Geometry Calculator** template and press **ENTER** to display the **Select point:** pop-up menu. Refer to **Figure 6-9**.

[C] - Indicates Position is a Circle Center

[P] - Indicates Position is a Point

Select point :			
▶	1. X	0.0000 Y	0.0000 [P]
	2. X	1.0000 Y	1.0000 [C]
	4. X	5.0000 Y	6.0000 [P]
	6. X	6.0000 Y	6.0000 [P]
	7. X	3.0000 Y	3.0000 [P]

CALGRCL

**Figure 6-9, Geometry Calculator, Select point: Pop-up Menu**

4. Highlight the required values and press **ENTER**. The **Select term:** pop-up menu prompts for **Both X and Y** values, **X only**, or **Y only**.
5. Select the required terms and press **ENTER** to copy the selected values to the Graphic Menu.

**NOTE:** Position coordinates can be recalled only to Graphic Menu entry fields that require X and/or Y coordinate values.

## Recalling Values from One Calculator into Another

Both the Math Calculator and the Triangle Calculator recall values from other calculators.

In the **Triangle Calculator**, press **Recall (F2)** to activate recall. In the **Math Calculator**, press an **ARROW** to activate recall.

#loops, 4-40

5000M CNC Programming and

Operations Manual, P/N

70000508, referenced, 1-1

5000M CNC Setup Utility

Manual, P/N 70000509,

referenced, 1-1, 4-65

6000M CNC Programming and

Operations Manual, P/N

70000487, 1-1

6000M CNC Setup Utility

Manual, P/N 70000490,

referenced, 1-1, 4-65

## A

absolute mode

block, 3-1

change, 3-4

hot key (E), 2-1

absolute move, 3-5

absolute zero, resetting, 3-12

absolute/incremental key (E), hot

key, 2-1

Action, 4-97

Activate, 4-97

adding, blocks to programs, 3-3

angle radius template, 3-19

arc

hot key (3), 2-1

move, compensation, 3-6

program

using center-end point

hot keys, 3-22

soft keys, 3-23

using center-included angle

hot keys, 3-25

soft keys, 3-25

using endpoint-radius, 3-20

hot keys, 3-21

soft keys, 3-21

select the plane, 3-20

template, 3-22

arrow keys, editing keys, 2-2

asterisk, displayed, 5-5

axes of rotation, illustration, 4-48

## B

basic drilling cycle

description, 4-1

graphic menu, illustration, 4-2

basic, drill cycles, 4-1

BasicDrill block, to program, 4-1

block number, search for, 5-4

bolt hole cycle

description, 4-9

to program, 4-9

Boring block, 4-4

boring cycle

description, 4-4

graphic menu, illustration, 4-4

to program, 4-4

Boss, 4-84

break and wear, BrkWearDet, 4-

65, 4-79

BrkWearDet, break and wear, 4-

65, 4-79

## C

calculator

geometry calculator, 6-7

math calculator, description, 6-1

recall values, into program, 6-15

right triangle calculator, 6-5

calculators, listed, 6-1

CalibPtPrb, spindle probe

calibration cycle

defined, 4-82

description, 4-84

CalibTIPrb, probe calibration, 4-

65, 4-67

call

a loop subprogram, 4-40

RMS subprogram, 4-40

subprogram, 4-38

subprograms from the main program,

4-39

canned cycles

library, 3-1

probing cycles, conventional

programming, 4-64

spindle probing cycles, conversational

programming, 4-81

cartesian coordinates, geometry

calculator, 6-7

change, hole dimensions, 4-1, 4-

4, 4-5

chip break cycle

description, 4-5

graphic menu, illustration, 4-5

- to program, 4-5
- circle templates, listed, 6-12
- circular pocket cycle
  - compensation, 3-7
  - description, 4-21
  - graphic menu, illustration, 4-21
  - to program, 4-21
- circular profile cycle
  - compensation, 3-7
  - description, 4-17
  - graphic menu, illustration, 4-17
  - to program, 4-18
- cleaning up, inside diameter, 4-25
- CLEAR key, editing keys, 2-2
- column of numbers, math, 6-3
- comment
  - asterisk, hot key (0), 2-1
  - block
    - comment out, 5-5
    - description, 5-5
    - to cancel, 5-6
    - to write, 5-5
- conversational
  - editor, More (F1) soft key, 5-6
  - programs
    - M, extension, 3-1
    - writing, 3-1
- conversational programming
  - probe cycles, description, 4-64
  - spindle probe cycles, description, 4-64
  - spindle probing
    - description, 4-81, 4-83
    - designations, 4-82
  - tool probe cycle, description, 4-66
  - tool probe cycle, designations, listed, 4-65
  - tool probe cycle, listed, 4-66
  - tool probe cycles, description, 4-64
- coordinates, finding, 3-1
- CornerIn, inside part corner find
  - defined, 4-82
  - description, 4-89
- CornerOut, outside part corner find
  - defined, 4-82
  - description, 4-87
- counter bore, existing holes, 4-25
- curved moves, programming, 3-20
- cut through holes, 4-25

- cutting direction, 4-13
- cycle compensation,
  - requirements, listed, 3-6

**D**

- decimal point, hot key, 2-1
- diameter special, DiaSpecMea, 4-65, 4-76
- DiamOfStd, 4-67
- DiaSpecMea, diameter special, 4-65, 4-76
- dim block, to program, 3-4
- disclaimer, iii
- DisDown, 4-84
- DistBack, 4-84, 4-88, 4-90, 4-91, 4-93, 4-98
- DistDown, 4-67, 4-70, 4-76, 4-79, 4-87, 4-89, 4-91, 4-93, 4-98
- DistInX, 4-84, 4-88, 4-90, 4-92, 4-94, 4-98
- DistInY, 4-84, 4-88, 4-90, 4-92, 4-94, 4-98
- DistPicks, 4-97
- DistSide, 4-87, 4-89
- drill
  - cycles
    - basic, 4-1
    - description, 4-1
    - listed, 4-1
  - pattern
    - description, 4-8
    - to program, 4-8
- drilling cycles, listed, 4-1
- Drilling Off block, 4-2, 4-5, 4-6
- DrillOff block, 4-1
- drilloff block, to program, 4-1
- dry run
  - all axes (M105), 3-27
  - cancel (M107), 3-27
  - mode
    - description, 3-27
    - M-codes, listed, 3-27
    - no Z-axis (M106), 3-27
    - successful, 3-2
- dwell
  - block, to add, 3-8
  - graphic menu, 3-8
  - hot key (8), 2-1
  - programming
    - description, 3-8



- using hot keys, 3-8
  - using soft keys, 3-8
- resolution, 3-8, 4-4
- DXF converter
  - output format, pop-up menu, 4-33
  - pockets with islands
    - description, 4-32
    - program example, 4-34
  - program listing, pop-menu, 4-33
- E**
- edge finding, EdgeFind, 4-86
- EdgeFind, single surface
  - measure/edge find
    - defined, 4-82
    - description, 4-86
- edit mode, hot keys, listed, 2-1
- editing
  - keys
    - arrow keys, 2-2
    - CLEAR key, 2-2
    - ENTER key, 2-2
    - listed, 2-2
  - program blocks, More (F1), 5-6
  - programs, conversational, 5-1
  - to search, 5-4
- editor, conversational, More (F1), 5-6
- edits
  - to exit, 5-3
  - to save, 5-3
  - unsaved, to cancel, 5-3
- elbow cavity and core,
  - illustration, 4-53
- elbow milling cycle
  - conical elbow details, illustration, 4-56
  - core & cavity detail, illustration, 4-56
  - details, illustration, 4-54
  - graphic menu, illustration, 4-57
  - moves, illustration, 4-54
  - programming, 4-53
  - starting point, orientation, illustration, 4-55
  - starting point, size, illustration, 4-55
  - to program, 4-57
- elbow mold cycle, compensation, 3-7
- ellipse
  - description, 4-42
  - graphic menu, illustration, 4-42
  - move, compensation, 3-6
  - programming, 4-42

- tool compensation, illustration, 4-44
- end of main, block, 4-37
- end of program, 3-3
- ending
  - main programs, 4-39
  - subprograms, 4-39
- EndMain, 4-39
- EndMain, last program block, 3-3
- EndMill block, to program, 4-62
- endpoint template, 3-22
- EndSub, 4-39
- engraving cycle
  - description, 4-58
  - sample program, 4-60
  - to program, 4-58
- ENTER key, editing keys, 2-2
- entry fields
  - optional, graphic menu, 3-4
  - required, graphic menu, 3-4
- EstAngle, 4-97
- EstDiam, 4-69, 4-74, 4-76, 4-79
- extension, M, 3-1

**F**

- F1, soft key, More,
  - conversational editor, 5-6
- F1, ToolPro, 4-66
- F10, Probe, 4-66
- F3, SpinPro, 4-66
- F5, Mill, 4-44, 4-66
- F6, RMS, 4-40
- F7, More, 4-44
- F9, Misc soft key, 5-6
- face pocket
  - graphic menu, illustration, 4-13
- face, the surface of a part, 4-13
- facing cycle
  - description, 4-13
  - to program, 4-13
  - tool approach, illustration, 4-13
- feed
  - block
    - description, 3-15
    - to program
      - hot keys, 3-15
      - soft keys, 3-15
  - hot key (4), 2-1
  - moves, programming, 3-17
- Feed, 4-95
- feedrate change, programming, 3-15

Find, 4-97  
FindActive, 4-97  
fixture offsets  
  changing, 3-12  
  define, 3-2  
  entry fields, 3-10  
  table  
    entry, to calibrate, 3-12  
    illustrated, 3-11  
    to activate, 3-11  
    values, manually typed, 3-12  
  to cancel, 3-11  
  to program, 3-10  
frame pocket cycle  
  compensation, 3-7  
  description, 4-23  
  graphic menu, illustration, 4-23  
  to program, 4-23

**G**

G, extension, 1-1  
GaugeDiam, 4-84  
geometry calculator  
  deleting, all elements, 6-13  
  deleting, elements, 6-13  
  description, 6-7  
  distance, calculate, 6-14  
  geometry list, 6-13  
  recall, last position, 6-14  
  recall, values, 6-17  
  screen, illustration, 6-8  
  templates  
    circle templates, 6-12  
    line templates, 6-11  
    listed, 6-9  
    point templates, 6-10  
  to activate, 6-7  
  to use, 6-8  
geometry list  
  element, details, 6-9  
  geometry calculator, 6-13  
  to display, 6-13  
graphic menu  
  basic drilling, illustration, 4-2  
  bolthole drill, illustration, 4-9  
  boring drilling, illustration, 4-4  
  chip breaking cycle, illustration, 4-5  
  circular pocket, illustration, 4-21  
  circular profile, illustration, 4-17  
  elbow milling, illustration, 4-57  
  ellipse, illustration, 4-42

  entry fields, types, listed, 3-4  
  face pocket, illustration, 4-13  
  frame pocket, illustration, 4-23  
  hole-mill, illustration, 4-25  
  irregular pocket, illustration, 4-30  
  mold rotation, illustration, 4-52  
  pattern drill, illustration, 4-8  
  peck drilling, illustration, 4-3  
  rectangular pocket, illustration, 4-19  
  rectangular profile, illustration, 4-15  
  RMS SUB, illustration, 4-41  
  spiral, illustration, 4-44  
  tapping cycle, illustration, 4-7  
  thread mill, illustration, 4-10  
  using, 3-3

**H**

height, standard starting, 3-1  
helical threads, 3-22  
hole mill pocket cycle  
  description, 4-25  
  graphic menu, illustration, 4-25  
  to program, 4-25  
home, 3-9  
homing method, 3-9  
hot key  
  absolute mode (E), 2-1  
  absolute/incremental key (E), 2-1  
  arc key(3), 2-1  
  comment asterisk (0), 2-1  
  decimal point key, 2-1  
  dwell key (8), 2-1  
  feed key (4), 2-1  
  inch mode (7), 2-1  
  incremental mode (E), 2-1  
  line move (2), 2-1  
  M-code key (6), 2-1  
  millimeter mode (7), 2-1  
  plane key (9), 2-1  
  rapid move (1), 2-1  
  sign change key (+/-), 2-1  
  spindle speed, 2-1  
  tool key (5), 2-1  
  unit key (7), 2-1  
  X-axis, 2-1  
  Y-axis, 2-1  
  Z-axis, 2-1  
hot keys  
  editing, program blocks, More (F1), 5-6  
  feed block, to program, 3-15  
  line move, to program, 3-17

- listed, 2-1
- plane block, to program, 3-14
- program
  - arc
    - using center-end point, 3-22
    - using center-included angle, 3-25
    - using endpoint-radius, 3-21
  - rapid move, to program, 3-16
  - RPM, to program, 3-15

**I**

- inch mode, 3-4
- inch mode, hot key (7), 2-1
- incremental command, 3-5
- incremental mode
  - change, 3-4
  - hot key (E), 2-1
- InOutBoss, inside or outside hole or boss center find
  - defined, 4-82
  - description, 4-91
- InOutWeb, inside or outside web or slot center find
  - defined, 4-82
  - description, 4-93
- inside corner finding, CornerIn, 4-89
- inside or outside hole or boss center find, InOutBoss, 4-82, 4-91
- inside or outside web or slot center find, InOutWeb, 4-82, 4-93
- inside part corner find, CornerIn, 4-82, 4-89
- inside profile, 4-15
- inside/outside hole/boss finding, InOutBoss, 4-91
- inside/outside web finding, InOutWeb, 4-93
- introduction, 1-1
- irregular pocket
  - (M9367) correct tool diameter, from a subprogram, 4-31
  - cycle
    - compensation, 3-7
    - description, 4-27
    - programming, 4-27
    - to program, 4-30
  - execution, 4-29
  - graphic menu, illustration, 4-30

- island, in rectangles, 4-23

**K**

- keys, editing, listed, 2-2

**L**

- last, program block, EndMain, 3-3
- LenDiamMea, length and diameter, 4-65, 4-69
- Length, 4-91, 4-93
- length and diameter, LenDiamMea, 4-65, 4-69
- length offset, 3-2
- length special, LenSpecMea, 4-65, 4-74
- LenSpecMea, length special, 4-65, 4-74
- line
  - (feed) moves, 3-17
  - block, move, programming, 3-19
  - move
    - compensation, 3-6
    - hot key (2), 2-1
    - programming, 3-17
    - to program
      - hot keys, 3-17
      - soft keys, 3-17
    - templates, listed, 6-11
    - tools, geometry calculator, 6-11
  - looping, subprograms, 4-37, 4-40

**M**

- M, extension, 1-1, 3-1
- M105, dry run, all axes, 3-27
- M106, dry run, cancel, 3-27
- M106, dry run, no Z-axis, 3-27
- M9367, correct tool diameter, irregular pocket milling, 4-31
- machine home
  - graphic menu, to activate, 3-9
  - return to, 3-9
- machine zero, 3-9
- manual tool diameter
  - measure for special tools, DiaSpecMea, 4-76
  - preset, DiaSpecMea, 4-65, 4-76
- manual tool length
  - measure for special tools, LenSpecMea, 4-74

- offset preset, LenSpecMea, 4-65, 4-74
- math
  - calculator
    - basics, listed, 6-2
    - description, 6-1
    - functions, listed, 6-4
    - numbers, storage, 6-5
    - operation keys, listed, 6-2
    - operations, multiple, 6-3
    - operations, order of, 6-4
    - parentheses, using, 6-3
    - recall values, 6-15
    - recall, values from other calculators, 6-17
    - soft keys, listed, 6-2
    - to activate, 6-1
    - to add, 6-3
    - to divide, 6-3
    - to multiply, 6-3
    - to subtract, 6-3
    - two number, operations, 6-3
  - functions, listed, 6-4
  - operation, soft keys, listed, 6-2
- MaxDiaAdj, 4-79
- MaxLenAdj, 4-79
- M-code
  - block, to program, 3-26
  - dry run mode, listed, 3-27
  - functions, listed, 3-26
  - hot key (6), 2-1
- MeasTyoe, 4-69
- measurement mode, 5-2
- memory, storing numbers, 6-5
- menus
  - bolthole drill, graphic menu, illustration, 4-9
  - ellipse, graphic illustration, 4-42
  - face pocket, graphic, illustration, 4-13
  - graphic
    - basic drilling, illustration, 4-2
    - boring drilling, illustration, 4-4
    - chip breaking cycle, illustration, 4-5
    - circular pocket, illustration, 4-21
    - circular profile, illustration, 4-17
    - elbow milling, illustration, 4-57
    - frame pocket, illustration, 4-23
    - hole-mill, illustration, 4-25
    - irregular pocket, illustration, 4-30
    - mold rotation, illustration, 4-52
    - pattern drill, illustration, 4-8
    - peck drilling, illustration, 4-3
    - rectangular pocket, illustration, 4-19
    - rectangular profile, illustration, 4-15
    - RMS SUB, illustration, 4-41
    - spiral, illustration, 4-44
    - tapping cycle, illustration, 4-7
    - thread mill, illustration, 4-10
  - pop-up, pocket, illustration, 4-12
- Mill (F5), 4-44
- mill cycle
  - description, 4-62
  - sample program, 4-63
  - to program, 4-62
- Mill, F5, 4-66
- millimeter mode, hot key (7), 2-1
- milling, cavities, 4-45
- milling, cores, 4-45
- mirroring and scaling, subprograms, 4-40
- mirroring, subprograms, 4-37
- mm mode, 3-4
- modal
  - move
    - block, 3-17
    - compensation, 3-6
    - programming, 3-17
    - setting, description, 3-1
- mold cycles, 4-45
- mold rotation
  - around X and Y axes
    - small radius, 4-46
  - axes of rotation, illustration, 4-48
  - categories, listed, 4-45
  - cutting a cavity, illustration, 4-49
  - cycle, compensation, 3-7
  - graphic menu, illustration, 4-52
  - programming, 4-45
  - rotation around the Z-axis, 4-51
  - rotations around X and Y axes
    - large radius, 4-50
    - XY rotations about Z, illustration, 4-49
    - XY symmetrical axis, illustration, 4-45
    - Z-axis, illustration, 4-51
- MoldRot block, to program, 4-52
- More (F7), 4-44
- More pop-up menu, to display, 5-6
- move
  - angle, specifying, illustration, 4-29
  - compensation, requirements, listed, 3-6
  - direction, determining, 4-28

moves with unknown endpoints,  
programming, 3-18

**N**

negative radius value, 3-21  
nesting subprograms, 4-37  
no move blocks, description, 3-4  
Nominal probe stylus diameter,  
4-68  
numbers, storing in memory, 6-5

**O**

Offset, 4-86, 4-88, 4-90, 4-92,  
4-94  
organizing programs, containing  
subprograms, 4-38  
output format pop-up menu,  
illustration, 4-33  
outside corner finding,  
CornerOut, 4-87  
outside part corner find,  
CornerOut, 4-82, 4-87  
outside profile, 4-17  
outside profile ramp moves,  
illustration, 4-15  
OvrFstFeed, 4-70  
OvrMedFeed, 4-70, 4-74, 4-76,  
4-80  
OvrRPM, 4-70, 4-74, 4-77, 4-80  
OvrSlwFeed, 4-70, 4-74, 4-76,  
4-80

**P**

P/N 70000487, *6000M CNC  
Programming and Operations  
Manual*, referenced, 1-1  
P/N 70000490, *6000M CNC  
Setup Utility Manual*,  
referenced, 1-1, 4-65  
P/N 70000508, *5000M CNC  
Programming and Operations  
Manual*, referenced, 1-1  
P/N 70000509, *5000M CNC  
Setup Utility Manual*,  
referenced, 1-1, 4-65  
parentheses, math calculator,  
6-3  
part programs, to develop, 3-1  
part zero location, 3-1  
part, moves toward, 3-1  
Pattern Drill. See drill pattern

pattern drill cycle  
description, 4-8  
graphic menu, illustration, 4-8  
peck drilling cycle  
description, 4-2  
graphic menu, illustration, 4-3  
to program, 4-3  
plane block, to program  
hot keys, 3-14  
soft keys, 3-15  
plane selection, ellipse and  
spiral, 4-41  
plane, hot key (9), 2-1  
pocket  
cycle, description, 4-12  
cycle, tool compensation, 4-12  
cycles, listed, 4-12  
pop-up menu, illustration, 4-12  
with islands  
description, 4-32  
DXF, program example, 4-34  
subroutines, example, 4-35  
using DXF, 4-32  
point definition, 6-10  
point identification tools, 6-8  
point of rotation, 4-41  
point templates  
description, 6-10  
listed, 6-10  
pop-up menus  
editing, program blocks, More (F1), 5-6  
More (F1), illustration, 5-7  
More (F7) engraving cycle, illustration,  
4-58  
output format, 4-33  
program listing, 4-33  
positive radius value, 3-21  
probe  
calibration, CalibTIPrb, 4-65, 4-67  
cycles, conversational programming,  
description, 4-64  
orientation, description, 4-68  
spindle cycles  
conversational programming,  
description, 4-64  
description, 4-81  
listed, 4-82  
tool cycles  
description, 4-64, 4-66  
designations, 4-65  
listed, 4-66

- tool-length offset, description, 4-64
- Probe, F10, 4-66
- ProbeMove, protected
  - positioning move
  - defined, 4-83
  - description, 4-95
- programming
  - feed block
    - hot keys, 3-15
    - soft keys, 3-15
  - line move
    - hot keys, 3-17
    - soft keys, 3-17
  - rapid move
    - hot keys, 3-16
    - soft keys, 3-16
  - RPM block
    - hot keys, 3-15
    - soft keys, 3-16
  - SetZero block, 3-14
- program
  - arc
    - using center-end point
      - hot keys, 3-22
      - soft keys, 3-23
    - using center-included angle
      - hot keys, 3-25
      - soft keys, 3-25
    - using endpoint-radius, 3-20
      - hot keys, 3-21
      - soft keys, 3-21
  - back up, 3-2
  - basics, description, 3-1
  - editing, conversational, 5-1
  - elbow milling cycle, 4-57
  - end of, 3-3
  - ending, main, 4-39
  - listing pop-up menu, illustration, 4-33
- program block
  - adding to program, 3-3
  - comment out, 5-5
  - comments, description, 5-5
  - editing, More (F1), 5-6
  - EndMain, last, 3-3
  - saving, 3-3
  - scroll, 5-4
  - to delete, 5-3
  - to edit, 5-4
  - to insert, 5-4
  - to jump, 5-5
  - to page, 5-5
  - writing, 3-3
- program editor, 3-3
  - conversational
    - from manual screen, activate, 5-1
    - from program directory, activate, 5-1
    - recall values, into program, 6-15
    - screen, illustration, 5-2
- program type
  - conversational, description, 1-1
  - G-code, description, 1-1
- programming
  - absolute mode, change, 3-4
  - an elbow milling cycle, 4-53
  - an ellipse, 4-42
  - arcs, 3-20
  - basic drill cycles, 4-1
  - circular pocket cycle, 4-21
  - circular profile cycles, 4-17
  - curved moves, 3-20
  - drill patterns, 4-8
  - dwell, 3-8
    - using hot keys, 3-8
    - using soft keys, 3-8
  - facing cycles, 4-13
  - feed moves, 3-17
  - feedrate change, 3-15
  - frame pocket cycles, 4-23
  - hole, 4-25
  - hole mill pocket cycle, 4-25
  - hot keys, listed, 2-1
  - inch/MM mode changes, 3-4
  - incremental mode, change, 3-4
  - irregular pocket cycle, 4-30
  - irregular pocket cycles, 4-27
  - line (feed) moves, 3-17
  - M-code block, 3-26
  - modal moves, 3-17
  - mold rotation, 4-45
  - MoldRot block, 4-52
  - move, using line block, 3-19
  - move, using rapid block, 3-19
  - moves with unknown endpoints, 3-18
  - part programs, 3-1
  - plane block
    - hot keys, 3-14
    - soft keys, 3-15
  - rapid move, 3-16
  - rectangular pocket cycles, 4-19
  - rectangular profile cycles, 4-15, 4-16
  - spindle RPM, 3-15
  - spiral, 4-44

- straight moves, 3-16
- tool change, 3-5
- protected positioning move,
  - ProbeMove, 4-83, 4-95
- protected probe positioning,
  - ProbeMove, 4-95
- R**
- ramp moves, 3-6
- rapid block, move, programming, 3-19
- rapid move
  - compensation, 3-6
  - hot key (1), 2-1
  - hot keys, 3-16
  - programming, 3-16
  - soft keys, 3-16
  - to program
    - hot keys, 3-16
    - soft keys, 3-16
- recall value
  - from one calculator, to another, 6-17
  - geometry calculator, from, 6-17
  - into program, 6-15
  - math calculator, from, 6-15
  - pop-up menu, from, 6-15
  - right triangle calculator, from, 6-16
- rectangular pocket cycle
  - compensation, 3-7
  - description, 4-19
  - graphic menu, illustration, 4-19
  - to program, 4-19
- rectangular profile cycle
  - compensation, 3-7
  - description, 4-15
  - graphic menu, illustration, 4-15
  - to program, 4-16
- reference point, 6-10
- repeat cycle
  - description, 4-60
  - sample program, 4-61
  - to program, 4-60
- RepeatMeas, 4-92
- repetitive
  - drilling cycle, subprograms, 4-37
  - operations, 4-12
  - operations, subprograms, 4-37
- return to machine home, 3-9
- ReturnHgt, 4-2
- right triangle calculator. *See* triangle calculator

- RMS
  - description, 4-40
  - SUB, graphic menu, illustration, 4-41
  - subprogram, entry fields, 4-41
  - subprogram, to call, 4-40
  - subprograms, 4-40
- RMS (F6), 4-40
- rotating, mirroring, and scaling.
  - See* RMS
- rotating, subprograms, 4-37
- rotation
  - around the Z-axis, 4-51
  - around X and Y axes
    - large radius, 4-50
    - small radius, 4-46
  - Z-axis rotation, start and end angles, 4-52
- rough and finish cycles,
  - subprograms, 4-37
- RPM block, to program
  - hot keys, 3-15
  - soft keys, 3-16
- RPM for calibration and tool measurement, 4-68, 4-70, 4-74, 4-77, 4-80
- S**
- saving, program block, 3-3
- scaling, subprograms, 4-37, 4-40
- screens
  - engraving cycle, illustration, 4-59
  - mill cycle, illustration, 4-62
  - repeat cycle, illustration, 4-60
- scroll, program, 5-4
- search, blocks, 5-4
- SearchDir, 4-86
- SearchQuad, 4-87, 4-89
- set plane graphic menu, 3-15
- SetZero block, 3-12
  - to program, 3-14
  - to set, 3-13
- Side, 4-91, 4-93
- sign change, hot key (+/-), 2-1
- single surface measure/edge find, EdgeFind, 4-82, 4-86
- sketch, elements, 6-8
- skew error find, SkewComp, 4-96
- skew error or angle find, SkewComp, 4-83, 4-96

- SkewComp, skew error or angle
    - find
    - defined, 4-83
    - description, 4-96
  - soft keys
    - feed block, to program, 3-15
    - labels, functions, listed, 5-3
    - line move, to program, 3-17
    - More (F1), editing, program blocks, 5-6
    - plane block, to program, 3-15
    - program
      - arc
        - using center-end point, 3-23
        - using center-included angle, 3-25
        - using endpoint-radius, 3-21
      - rapid move, to program, 3-16
      - RPM, to program, 3-16
  - spindle
    - probe calibration
      - CalibPtPrb, 4-84
      - cycle, CalibPtPrb, 4-82, 4-84
    - probe cycles
      - conversational programming,
        - description, 4-64
      - description, 4-81
      - listed, 4-82
      - RPM, programmable, 3-15
      - speed, hot key, 2-1
  - SpinPro, F3, 4-66
  - spiral
    - geometry, 4-44
    - graphic menu, illustration, 4-44
    - inward, 4-44
    - move, compensation, 3-6
    - outward, 4-44
    - programming, 4-44
  - StartHgt, defined, 4-2
  - starting, subprograms, 4-39
  - stepover
    - face pocket, value, 4-14
    - facing cycle, 4-13
    - move direction, 4-28
    - move orientation, illustration, 4-27
    - orienting from subprogram, illustration, 4-28
  - Stepover values, 4-14
  - straight moves, programming, 3-16
  - Sub block, to program, 4-39
  - Sub#, 4-40
  - subprogram
    - call, 4-38
    - call a loop, 4-40
    - calling, 4-39
    - description, 4-37
    - ending, 4-39
    - example, 4-37
    - looping, 4-40
    - M9367, correct tool diameter, irregular pocket milling, 4-31
    - orientation, illustration, 4-46
    - program structure, 4-37
    - programs, containing, 4-38
    - repetitive drilling cycle, 4-37
    - RMS, to call, 4-40
    - rotating, mirroring, and scaling, 4-40
    - rough and finish cycles, 4-37
    - specific, illustration, 4-47
    - to program, 4-39
    - to write, 4-38
    - Z-axis rotation, illustration, 4-51
  - subroutines, pockets with islands, example, 4-35
- T**
- tapping cycle
    - description, 4-6
    - graphic menu, illustration, 4-7
    - to program, 4-7
  - templates
    - circle, 6-12
    - line, 6-11
    - point, 6-10
  - thread milling cycle
    - description, 4-10
    - graphic menu, illustration, 4-10
    - sample program, 4-11
    - to program, 4-10
  - TLO. See tool-length offset
  - TLO, defined, 4-64
  - tool
    - approach, facing cycle, illustration, 4-13
    - change, programming, 3-5
    - compensation, automatic, 3-6
    - compensation, ellipse, illustration, 4-44
    - diameter, 3-2
    - diameter compensation, activating, 3-6
    - diameter, correct for irregular pocket milling, M9367, 4-31
    - hot key (5), 2-1
    - to activate, 3-5



to change, 3-5  
 tool breakage, length and diameter wear detection, BrkWearDet, 4-65, 4-79  
 tool length and diameter offset preset, LenDiamMea, 4-65, 4-69  
 tool probe calibration cycle, CalibTIPrb, 4-65, 4-67  
 tool probe cycles  
   description, 4-64, 4-66  
   designations, listed, 4-65  
   listed, 4-66  
 Tool#, 4-40  
 tool# block, 3-5  
 ToolComp command, 3-6  
 tooling, organize, 3-2  
 tool-length offset, probe, description, 4-64  
 ToolPro, F1, 4-66  
 Top, 4-84, 4-87, 4-89, 4-91, 4-93, 4-97  
 triangle calculator  
   description, 6-5  
   recall, values, 6-16  
   recall, values from other calculators, 6-17  
   screen, to hide, 6-7  
   to activate, 6-5  
   using, 6-6  
   value, to store, 6-6  
 troubleshoot, finished programs, 3-2

**U**

unit block, to program, 3-4  
 unit, hot key (7), 2-1  
 units mode, 5-2  
 Update, 4-80

**W**

warranty, iii

Width, 4-91, 4-93  
 word, search for, 5-4  
 writing, conversational programs, 3-1  
 writing, program blocks, 3-3

**X**

X-axis, hot key, 2-1  
 Xincr, 4-40  
 XMinus, 4-86  
 XMinusYMinus, 4-87, 4-89  
 XMinusYPlus, 4-87, 4-89  
 X-offset coordinate, 3-10  
 XPlus, 4-86  
 XPlusYMinus, 4-87, 4-89  
 XPlusYPlus, 4-87, 4-89  
 XStepover, 4-14

**Y**

Y-axis, hot key, 2-1  
 Yincr, 4-40  
 YMinus, 4-86  
 Y-offset coordinate, 3-10  
 YPlus, 4-86  
 YStepover, 4-14

**Z**

Z final pick, SLOW feedrate, 4-70, 4-74, 4-76, 4-80  
 Z first pick  
   FAST feedrate, 4-70  
   MEDIUM feedrate, 4-67, 4-70, 4-74, 4-76, 4-80  
 Z-axis, hot key, 2-1  
 ZDepth, defined, 4-2  
 ZFeed, 4-40  
 Zincr, 4-40  
 ZMinus, 4-86  
 Z-offset coordinate, 3-11  
 ZPlus, 4-86

# ANILAM

## U.S.A.

ANILAM

One Precision Way  
Jamestown, NY 14701

☎ (716) 661-1899

☎ (FAX) (716) 661-1884

✉ anilaminc@anilam.com

## ANILAM, CA

16312 Garfield Ave., Unit B  
Paramount, CA 90723

☎ (562) 408-3334

☎ (FAX) (562) 634-5459

✉ anilamla@anilam.com

**Dial "011" before each number when calling  
from the U.S.A.**

## France

ANILAM S.A.R.L.

2 Ave de la Cristallerie  
B.P. 68-92316

Serves Cedex, France

☎ +33-1-46290061

☎ (FAX) +33-1-45072402

✉ courrier@acu-rite.fr

## Germany

ANILAM GmbH

Fraunhoferstrasse 1  
D-83301 Traunreut

Germany

☎ +49 8669 856110

☎ (FAX) +49 8669 850930

✉ info@anilam.de

## Italy

ANILAM Elettronica s.r.l.

10043 Orbassano

Strada Borgaretto 38  
Torino, Italy

☎ +39 011 900 2606

☎ (FAX) +39 011 900 2466

✉ info@anilam.it

## Taiwan

ANILAM, TW

No. 246 Chau-Fu Road  
Taichung City 407

Taiwan, ROC

☎ +886-4 225 87222

☎ (FAX) +886-4 225 87260

✉ anilamtw@anilam.com

## United Kingdom

ACI (UK) Limited

16 Plover Close, Interchange Park  
Newport Pagnell

Buckinghamshire, MK16 9PS

England

☎ +44 (0) 1908 514 500

☎ (FAX) +44 (0) 1908 610 111

✉ sales@aciuk.co.uk

## China

Acu-Rite Companies Inc.(Shanghai Representative Office)

Room 1986, Tower B

City Center of Shanghai

No. 100 Zunyi Lu Road

Chang Ning District

200051 Shanghai P.R.C.

☎ +86 21 62370398

☎ (FAX) +86 21 62372320

✉ china@anilam.com